

JVC®

SR-L910E/EK VIDEO CASSETTE RECORDER

VIDEO CASSETTE RECORDER

SR-L910E SR-L910EK

INSTRUCTIONS (A)

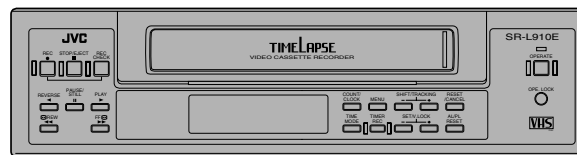

TIME LAPSE

Before you begin operation this unit.
Please read the instruction carefully to be
sure you get the best possible performance.

JVC®

VICTOR COMPANY OF JAPAN, LIMITED

JVC® is a registered Trademark owned by VICTOR COMPANY OF JAPAN, LTD.
JVC® is a registered Trademark in Japan, the U.S.A., the U.K. and many other countries.
© 2001 VICTOR COMPANY OF JAPAN, LIMITED

 Printed in Thailand
LLT0014

LLT0014

INTRODUCTION
CONTROLS AND CONNECTORS
CONNECTIONS
MONITOR ON-SCREEN DISPLAY
SETTING OF THE FUNCTION MENU SWITCHES
PREPARATION
RECORDING
PLAYBACK AND SPECIAL EFFECTS PLAYBACK
TROUBLE-SHOOTING
OPTIONAL SA-K97U SS-20C INTERFACE BOARD
APPENDIXES

SAFETY PRECAUTIONS

Warning Notice

FOR YOUR SAFETY (Australia)

1. Insert this plug only into effectively earthed three-pin power outlet.
2. If any doubt exists regarding the earthing, consult a qualified electrician.
3. Extension cord, if used, must be three-core correctly wired.

IMPORTANT

Connection to the mains supply in the United Kingdom. DO NOT cut off the mains plug from this equipment. If the plug fitted is not suitable for the power points in your home or the cable is too short to reach a power point, then obtain a proper safety approved extension lead/adaptor or consult your dealer.

BE SURE to replace the fuse only with an identical approved type, as originally fitted, and to replace the fuse cover.

If nonetheless the mains plug is cut off remove the fuse and dispose of the plug immediately, to avoid a possible shock hazard by inadvertent connection to the mains supply.

If this product is not supplied fitted with a mains plug then follow the instructions given below: DO NOT make any connection to the Larger Terminal coded E or Green.

The wires in the mains lead are coloured in accordance with the following code:



If these colours do not correspond with the terminal identifications of your plug, connect as follows:
Blue wire to terminal coded N (Neutral) or coloured Black.
Brown wire to terminal coded L (Live) or coloured Red.
If in doubt — consult a competent electrician.

CAUTION

- When you are not using the recorder for a long period of time, it is recommended that you disconnect the power cord from the mains outlet.
- Dangerous voltage inside. Refer internal servicing to qualified service personnel. To prevent electric shock or fire hazard, remove the power cord from the mains outlet prior to connecting or disconnecting any signal lead or aerial.

POWER SYSTEM

Connection to the mains supply

This unit operates on voltages of 220 to 240 V AC, 50/60 Hz.

WARNING:

TO PREVENT FIRE OR SHOCK HAZARD, DO NOT EXPOSE THIS APPLIANCE TO RAIN OR MOISTURE.

CAUTION

To prevent electric shock, do not open the cabinet. No user serviceable parts inside. Refer servicing to qualified service personnel.

Note:

The rating plate and the safety caution are on the rear of the unit.

The OPERATE button does not completely shut off mains power from the unit, but switches operating current on and off.

Notes on the built-in lithium battery

WARNING:

THE UNIT CONTAINS A BUILT-IN LITHIUM BATTERY FOR MEMORY BACK-UP THAT MUST ONLY BE REPLACED BY SUITABLY QUALIFIED SERVICE PERSONNEL. FOR BATTERY REPLACEMENT, TAKE THE UNIT TO YOUR DEALER OR A JVC SERVICE STATION.

(Danish)

ADVARSEL!
Lithiumbatteri — Eksplosionsfare.
Udskiftning må kun foretages af en
sagkyndig.
og som beskrevet i servicemanualen.

COPYRIGHT © 1998 VICTOR COMPANY OF JAPAN, LIMITED
Printed in Japan

OPERATION LOCK

By engaging the operation lock system [OPE.LOCK], you can prevent accidental or deliberate interference with recording operation or power supply.
When this function is activated, all operation buttons are disabled. However, you can still control the recorder with the remote control or RS-232C control.

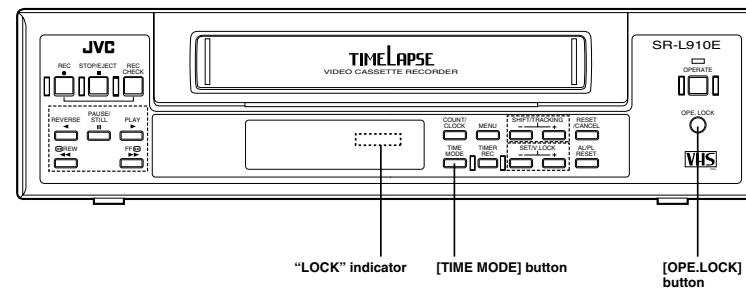

- 1 Engage the Rec or Play mode.
- 2 While pressing the [OPE.LOCK] button, press the [TIME MODE] button. "LOCK" is shown on the display, indicating that the Operation Lock mode is engaged.
- 3 To unlock the VCR, press the [TIME MODE] button while pressing the [OPE.LOCK] button. The "LOCK" indication on the display disappears and the unit can now be operated normally.

To prevent unauthorized use, detach this page and keep it in a safe place.

CONTENTS

1 INTRODUCTION

1-1 Major Features	6
1-2 Periodical Maintenance	6
1-3 Precautions	7
1-4 Daily Inspection	7

2 CONTROLS AND CONNECTORS

2-1 Front Panel	8
2-2 Display	10
2-3 Rear Panel	11

3 CONNECTIONS

3-1 Connecting to a Camera	13
3-2 Connecting a System Using a Sequential Switcher	14
3-3 Connecting the Rear Panel Input/Output Terminal Connections	15

4 MONITOR ON-SCREEN DISPLAY

4-1 On-Screen Display in the Time/Date and Record Mode	16
4-2 Main Menu Display	17
4-3 Alarm Input/Power Loss Data Display	18
4-4 Hour Meter Display	18

5 SETTING OF THE FUNCTION MENU SWITCHES

5-1 Function Menu Switch Setting	19
5-2 Contents of the Function Menu Switches	20

6 PREPARATION

6-1 Cassette Loading/Unloading	23
6-2 Date and Time setting	23
6-3 Summer Time Compensation	25
6-4 Selection of Record/Play Mode	25

7 RECORDING

7-1 Preparation	26
7-2 Recording	27
7-3 Timer Recording	28
7-4 Alarm Recording	33
7-5 Sensor Recording	35
7-6 Repeat Recording	36
7-7 Series Recording	37
7-8 Recording with External VCR Activation Signal	38
7-9 How to Restore Recording After Power Failure	39
7-10 External Timer Recording	39
7-11 Tape End Buzzer	39

8 PLAYBACK AND SPECIAL-EFFECTS PLAYBACK

8-1 Preparation	40
8-2 Playback	40
8-3 Special-Effects Playback	41
8-4 Index Search	42
8-5 Tracking/V. Lock Adjustment	42

9 TROUBLESHOOTING

9-1 Error Indication	43
9-2 No Error Indication	44

10 OPTIONAL SA-K97U RS-232C INTERFACE BOARD

10-1 Installation of the SA-K97U	45
10-2 SA-K97U Specifications	46
10-3 SA-K97U RS-232C Protocol & Commands	47

11 APPENDIXES

11-1 Rear Panel's Input/Output	54
11-2 Specifications	55



The SR-L910E/EK is a video cassette recorder able to execute timelapse recording with VHS cassettes. Use only video cassettes bearing the **VHS** mark. This unit is designed for professional use.

JVC is not liable for compensation for loss or damage to recordings in the event this unit fails to record or play back properly because the unit malfunctions or a defective video cassette tape is used.

Please note that it may be unlawful to use any material recorded from TV broadcast programs or pre-recorded programs without the consent of the owner of copyright, except in cases where this material is recorded exclusively for personal use.

1 INTRODUCTION

1-1 Major Features

- **24-hour long-time recording with a 180-minute tape**
Recording times are selectable from 3 hours (SP mode) and 12/24 hours (Timelapse mode). Monitor image recording for up to one-day (24-hour) is possible with a 180-minute tape.
- **Audio monitoring**
Audio signals can be recorded in the 12-hour/24-hour Timelapse mode, as well as in the conventional 3-hour mode. This strengthens surveillance capabilities by providing both audio and video information.
- **Alarm recording function**
When an alarm signal is input in the Timelapse Record mode, the 3-hour mode is automatically engaged. Alarm recording time can be selected from 5, 15, 30, 60, 120, or 180 sec., to tape end or set manually.
An index code is automatically recorded when alarm recording starts. Used as an alarm cue signal, this allows quick access to alarm recording points with the Index Search function.
- **Sensor recording**
Whenever an alarm signal is input in the Stop mode, the Record mode is automatically engaged.
- **Time/date generator**
Superimposes the year, month, date, minute and second on the image during recording. Also allows you to use the menu screen to display the number of alarms, alarm time, and the number of the power failures.
- **Timer recording function**
Two types of timer recording are available: based on the date (up to 8 programs) or based on the day of the week.
- **Recording Check function**
Pressing the [REC CHECK] button during recording allows you to check the status of the recording in progress. When activated via the corresponding function menu switch, the built-in head cleaner automatically cleans the heads whenever inferior picture quality is detected during Recording Check. After cleaning, the Recording Check operation is executed again automatically (Auto Recording Check function).
- **Operation lock system**
To prevent accidental or deliberate interference with VCR operation, a secret operation lock system is provided.
- **Warning function**
Error indications are shown on the front panel display.
- **Power-off video throughput function**
Even when the power is off, the camera's EE input can be output from the VCR.
- **Camera switching signal output terminal**
- **Automatic re-start of recording after a power failure**
- **Digital hour meter display**
- **Repeat recording/series recording function**
- **Recording control with external activation signal**
- **Alarm recording, tape end and warning electronic buzzer**
- **Summer time compensation function**
- **Wired remote control (optional)**
- **RS-232C control (with optional SA-K97U RS-232C interface board installed)**
The SR-L910E/EK can be controlled via a personal computer. Operation status can be monitored on the computer.

1-2 Periodical Maintenance

This VCR incorporates precision mechanical parts which will collect dirt over time and ultimately deteriorate and wear out. Over long periods of use, dirt and dust accumulates on the heads, drums and tape transport mechanisms. Dust which penetrates the VCR (especially during outdoor use) also promotes the wear and deterioration of mechanical parts by causing poor contact between tape and heads. This also prevents the VCR from maintaining video and audio quality at high levels. To prevent wear and deterioration, clean the heads regularly using a head cleaning tape. However, because a head cleaning tape alone cannot clean the entire tape transport mechanism, this should also be inspected periodically to prevent any problems that could result from a sudden failure.

As replacement and adjustment of parts require advanced skills and specialized equipment, please contact the person in charge of professional video equipment at your nearest JVC-authorized service agent for servicing.

Monitoring Usage Time

The total operation time reached by an ordinary home VCR in 5 or 6 years may be reached by a professional VCR in as few as 5 or 6 months. Therefore, it is important that the total hours of operation be carefully monitored. An hour meter in the on-screen display (see page 18) shows the accumulated time. In the chart below, the hours accumulated in each month are shown in relation to the number of hours used per day. Times shown inside shaded area indicate that maintenance should be performed.

Usage time per day	1 month	2 months	3 months	6 months	12 months
2 hours	60	120	180	360	720
8 hours	240	480	720	1440	2880
12 hours	360	720	1080	2160	4320
24 hours	720	1440	2160	4320	8640

Periodic Maintenance

Check or replace the following mechanical parts according to the running time.

Running time	1000H	2000H	3000H	4000H
Drum ass'y (including heads)	△	○	○	●
Pinch rollers	△	○	○	●
Drive parts	△	△	△	○

- △ : Cleaning
- : Check or replace as required.
- : Replace

- Maintenance requirements may vary depending on the operating environment and usage. The information above should be used as a reference guide.

1 INTRODUCTION

1-3 Precautions

Handling and storage place

- **Avoid using the unit in places subject to the following conditions:**
 - extreme heat or cold
 - strong magnetic fields (do not use a transceiver within 2 meters of this unit)
 - high humidity
 - dust and soil
 - vibrations
 - variations in temperature
- **Use this unit in horizontal (flat position) only.**
- **Do not leave the unit in the Still or Record Pause mode for a long time as this may damage the tape.**
To minimize tape damage, this VCR automatically enters the Stop mode after about 5 minutes have passed in the Still or Record Pause mode.
- **Handle the unit carefully**
 - Do not place anything heavy on the unit (a monitor, etc.). A malfunction may occur.
 - Do not put any foreign substance into the cassette loading slot.
 - Avoid violent shocks to the recording chassis during transportation. Remove the cassette tape from the unit for transportation.
- Turn off the power to save electricity when not using the unit.

Condensation

- **Condensation**
When cold beer is poured into a glass, water drops appear on the glass's surface. This phenomenon is called "condensation". When condensation occurs on the VCR's head drum and tape guides it may damage the tape.

- **Condensation occurs in the following cases.**
 - When the VCR is moved from a cold place to a warm place.
 - In a room that has just been heated or in an area directly exposed to a cooler.
 - When there is excessive humidity

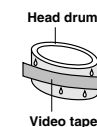

- **When condensation is expected to occur**
Turn the power of the VCR on before use.

Video cassette

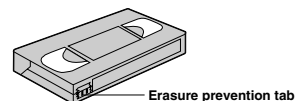

- Timelapse recording is performed over very long periods of time which means that a durable tape is required.
- Use an E-180 tape or shorter.
 - Do not use extended tapes (180 minutes or more such as E-240).

- Only use video cassette bearing the **VHS** mark.
- To prevent accidental erasure of a recorded tape, break the erasure prevention tab on the cassette. To use a cassette with a broken tab, place a piece of cellophane tape over the broken tab.
- Video cassettes cannot be used upside down.
- Leaving the tape in a partially wound condition for a long time may damage the tape. Rewind the tape to the beginning before storage.

1-4 Daily Inspection

Although this unit has been designed for reliable operation over a long period of time, a daily inspection is recommended to ensure optimum performance. In particular, be sure to check the repeat recording function on a daily basis.

Inspection procedure

- 1 Turn on the power for all units connected to the surveillance system.
- 2 Check the quality of the image shown on the monitor.
- 3 Check that the date and time shown on the monitor are correct.

- 4 Rewind the tape recorded the previous day for several seconds.
- 5 Press the play button for playback.
- 6 Check that the playback picture is normal.
- 7 Check that the recorded date and time are correct.
 - This unit includes a Recording Check function (using the [REC CHECK] button) and an Automatic Recording Check function for daily checking of recording quality.

If any problems are found after inspection, turn the power off, unplug the power plug from the AC outlet, and contact your JVC dealer.

2 CONTROLS AND CONNECTORS

2-1 Front Panel

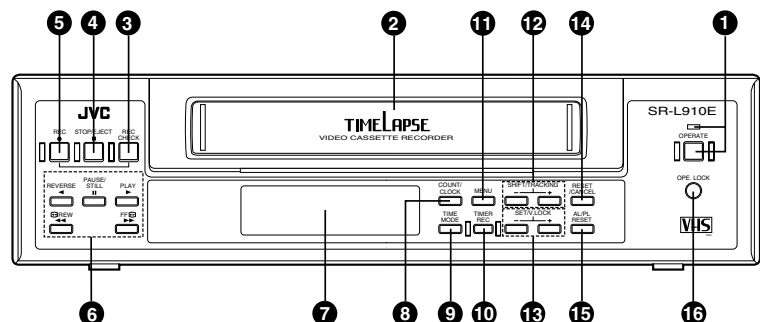

1 [OPERATE] button

Press to turn the operating power ON/OFF. When this button is ON, the OPERATE indicator lights and the unit can be operated. When a cassette is inserted, the power switches on and the OPERATE indicator lights automatically.

The OPERATE button does not completely shut off the mains power to the unit, but switches the operating current on and off.

2 Cassette loading slot

For cassette loading and unloading. Use a VHS cassette tape.

3 [REC CHECK] button

Use to check recording.

When pressed in the Record mode, this will rewind the tape about 4 seconds and then play back the rewind section so that the recording quality can be checked.

After playback, the Record mode is automatically re-engaged at the point where recording was interrupted.

- The FM level is checked during playback in Recording

Check operation to determine whether or not picture quality is defective. If it is judged defective, the heads are automatically cleaned. How this operation is performed is determined by the setting of the [REC CHECK] switch in the function menu.

— When set to "MANUAL":

Head cleaning is performed once and recording resumes.

— When set "AUTO":

Head cleaning is performed once and recording is resumed for several seconds. Then, Recording Check operation is performed again.

If picture quality is again judged defective, head cleaning is performed once again and "E-09" is shown on the display to indicate that there is a problem. Recording will continue, however.

4 [STOP/EJECT] button

- Stops the tape.
- Ejects the tape when pressed in the Stop mode.

5 [REC] button

Starts recording when pressed in the Stop mode.

6 Operation buttons

[PLAY] button

Starts playback.

[PAUSE/STILL] button

- Temporarily stops recording when pressed in the Record mode.
- Displays a still picture when pressed in the Play mode.
- Advances field by field when pressed in the Still mode. Pressing this button for more than 2 seconds starts continuous field-by-field playback (slow motion).

[REVERSE] button

Starts reverse playback when pressed in the Play or Still mode.

[FF] button

- Fast forwards the tape.
- Starts fast-forward shuttle search when pressed in the Play mode.
- If the function menu switch <INDEX SEARCH> is set to ON and an index-recorded tape is loaded, Index (alarm) Search starts in the forward direction when this button is pressed in the Stop or Play mode.

Select whether the index signal is to be recorded during alarm signal input or every hour (exact hour with no minute and second) using the function menu switch <INDEX ALARM/SKIP>.

[REW] button

- Rewinds the tape.
 - Starts reverse shuttle search when pressed in the Play mode.
 - If the function menu switch <INDEX SEARCH> is set to ON and an index-recorded tape is loaded, Index (alarm) Search starts in the reverse direction when this button is pressed in the Stop or Play mode.
- Select whether the index signal is to be recorded during alarm signal input or every hour (exact hour with no minute and second) using the function menu switch <INDEX ALARM/SKIP>.

2 CONTROLS AND CONNECTORS

2-1 Front Panel

7 Display section

- For details, refer to page 10.

8 [COUNT/CLOCK] button

Press this button to select the time display or tape counter in the display. When the power is turned off, the time is displayed.

9 [TIME MODE] button

Use to select the recording or playback time mode. Each time this button is pressed, the recording time mode changes in the following sequence.

3H (VHS SP mode) → L12 (12-hour Timelapse mode) → L24H (24-hour Timelapse mode) → 3H (VHS SP mode)

Playback Time Mode will differ depending on how the function menu switch <NOISELESS PLAY> is set.

When NOISELESS PLAY is set to OFF: 3H (VHS SP mode) → L12 (12-hour Timelapse mode) → L24 (24-hour Timelapse mode) → 3H (VHS SP mode)

When NOISELESS PLAY is set to ON: 3H (VHS SP mode) → 12 (12-hour Noiseless playback mode) → 24 (24-hour Noiseless playback mode) → 3H (VHS SP mode)

The selected recording/playback time mode is shown on the display.

10 [TIMER REC] button

Press this button to execute the timer recording. For details, refer to "Timer Recording" on page 28.

11 [MENU] button

Press this button to display the date, time setting, timer program setting, various function menu setting and hour meter. Press again to cancel the display.

12 [SHIFT/TRACKING +, -] buttons

- Press to select an item in date/time setting, timer program setting and function menu setting.
- Press to adjust tracking and reduce noise if there are tracking problems in the 3H (VHS SP) mode or during search.
- Tracking adjustment is not possible in the L12H and L24H Timelapse Play mode.

13 [SET/V. LOCK +, -] buttons

- Press to set values in date/time setting, timer program setting and function menu setting.
- Press to reduce the vertical shifting of the picture in the Still mode.

14 [RESET/CANCEL] button

- Normally press this button to reset the tape counter to 0000.
- When the buzzer sounds, press this button to stop the buzzer sound. Alarm and sensor buzzer will not stop sounding.
- In the Timer Program Setting mode, press this button to cancel the program settings. For details, refer to "Timer Recording" on page 31.

15 [AL/PL RESET] alarm/power loss reset button

Press this button to stop alarm recording or reset the alarm input or power loss data. For details, refer to page 34.

16 [OPE. LOCK] button

Press to activate the operation lock function.

2 CONTROLS AND CONNECTORS

2-2 Display

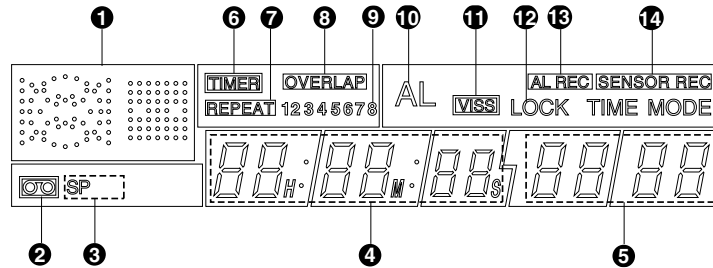

- 1 Operation mode display**
Shows the operation modes.

Playback	Recording	Rewind	Fast-forward	Continuous field advance playback
Still	Record-pause	Rewind search	Fast-forward search	Reverse playback

* (●) mark in the Rec/Pause mode is shown in red.

- 2** **Cassette indication**
Lights when a cassette is loaded. Blinks when a cassette is being ejected.
- 3** **SP/LP indication**
Shows the VHS standard (SP) mode during recording/playback.
During Timelapse Recording/Playback mode, the SP indicator is shown.
- 4** **Tape counter/time indication**
- When the power is turned on, the tape counter or current time are shown. The display can be selected with the [CNT/TIME] button.
 - When the power is turned off, the present time (hour, minute, second) is shown.
- 5** **Recording/playback mode time display**
- Shows the recording/playback mode set with the [TIME MODE] button.
 - When a tape ends in the Record mode, the record time mode indication goes out and the "End" indication blinks (when the <REC REMAIN> menu switch is set to "OFF"). If the <REC REMAIN> menu switch is set to "180S" or "360S", the "End" indication blinks 3 minutes or 6 minutes before the tape ends.
 - When an problem occurs, the error indication "E-#*" blinks. For details, refer to page 43.
 - During the index search by RS-232C Command, the index number is indicated in 2 digits (00-99). During the index search by FF/REW Button, the index number indicates 01 and 00 only.

- 6** **TIMER indication**
Lights during timer recording programming/operation.
- 7** **REPEAT indication**
Lights when the VCR is in the Repeat Record mode.
- 8** **OVERLAP indication**
Blinks when programs scheduled for timer recording overlap.
- 9** **Timer program number**
During timer recording, the number of program being recorded blinks.
When the timer recording ends, this number goes out.
- 10** **AL (alarm) indication**
Shown during alarm recording. Blinks when alarm recording ends.
- 11** **VISS indication**
Shown when the alarm recording start point is index-searched. For details, refer to "Index Search" on page 42.
- 12** **LOCK indication**
Lights when the operation lock function is activated.
- 13** **AL REC (alarm recording) indication**
Lights when the function menu switch <ALARM REC> is set to "ON".
- 14** **SENSOR REC (sensor recording) indication**
Lights when the function menu switch <SENSOR REC> is set to "ON".

2 CONTROLS AND CONNECTORS

2-3 Rear Panel

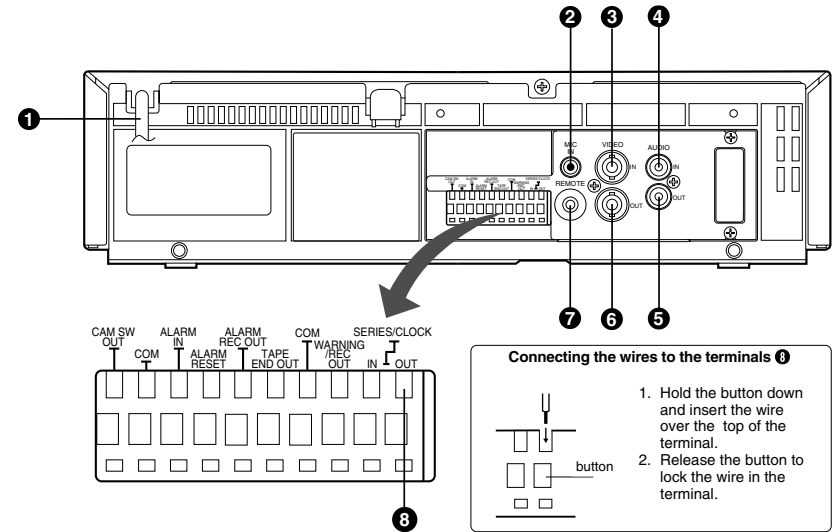

- 1** **Power cable**
Connect the power plug to an AC 220-240 V, 50/60 Hz outlet.
- 2** **[MIC IN] mic input connector**
Connect a microphone with 3.6-mm dia. plug. When signals are input from both the microphone connector and the audio input connector, audio signals are mixed and recorded.
- 3** **[VIDEO IN] video input connector (BNC)**
Receives composite video signals from a connected camera or other video source.
- 4** **[AUDIO IN] audio input connector (RCA)**
Receives audio signals from a connected audio source.
- 5** **[AUDIO OUT] audio output connector (RCA)**
Outputs audio signals.
- 6** **[VIDEO OUT] video output connector (BNC)**
Outputs composite video signals. Input camera signals (composite video signals) can still be output through this connector even when no power is supplied to the unit (Power-Off Video Throughput function).
- 7** **[REMOTE] remote connector (RCA)**
Connect the optional RM-G30U remote control.

- 8** **[SERIES/CLOCK OUT] series recording signal/clock reset signal output terminal**
Outputs the series recording signals or clock reset signals.
Select the output signal with the <TERMINAL SEL 1> menu switch.
- Series recording signal output**
When the <TERMINAL SEL 1> menu switch is set to "SERIES", the series recording signal is output.
 - Connect to the other VCR series recording signal input terminal. When the tape being recorded in this unit ends, a signal is output from this terminal to the connected VCR.
 - Select the signal output timing with the <REC REMAIN> menu switch (tape end, or 3 minutes or 6 minutes before the tape ends).
 - Clock reset signal output**
When the <TERMINAL SEL 1> menu switch is set to "C.ADJ.", the clock reset signal is output when the internal clock is at AM0:00 and PM0:00. When connected to the [CLOCK IN] terminal of another SR-L910E/EK, this unit's time can be synchronised with the time on the other VCR if the time difference is within ± 30 seconds.

Connecting the wires to the terminals 8

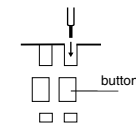

- Hold the button down and insert the wire over the top of the terminal.
- Release the button to lock the wire in the terminal.

2 CONTROLS AND CONNECTORS

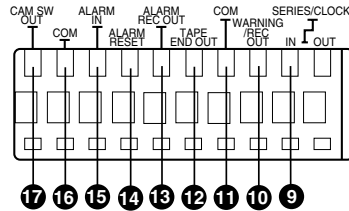
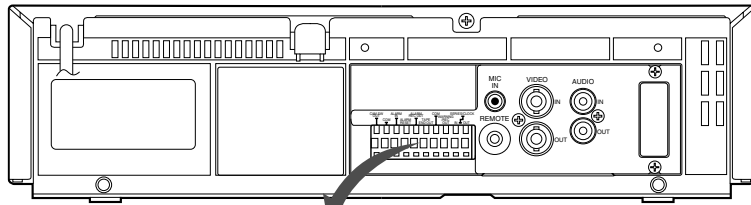

Connecting the wires to the terminals ⑨ to ⑰

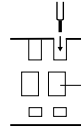

1. Hold the button down and insert the wire over the top of the terminal.
2. Release the button to lock the wire in the terminal.

⑨ [SERIES/CLOCK IN] series recording signal/clock reset signal input terminal

Input the series recording signals, VCR activation signals from the external control equipment or clock reset signals.

Select the input signal with the <TERMINAL SEL 1> menu switch.

• Series recording signal input

When the <TERMINAL SEL 1> menu switch is set to "SERIES", the series recording signal is input.

• Connect to the other VCR series recording signal output terminal.

• When a series recording signal is received from the other VCR, recording starts automatically.

• VCR activation signal input

• When the <TERMINAL SEL 1> menu switch is set to "EXT", recording start and stop can be controlled with external signal input.

• Connect to an external control device.

When a VCR activation signal (ground input) is received, recording starts automatically and continues for as long as the VCR activation signals are input.

• Clock reset signal input

When the <TERMINAL SEL 1> menu switch is set to "C.ADJ", the clock reset signal from the master clock can be received.

• Inputting the clock reset signal synchronises the time with the master clock time if the time difference is within ± 30 seconds. If the difference exceeds 30 seconds, the time will not be adjusted correctly.

⑩ [WARNING/REC OUT] warning signal/rec signal output terminal

Outputs a warning signal or recording mode signal. The type of output signal can be selected with the <TERMINAL SEL 2> menu switch.

• Warning signal output

When the <TERMINAL SEL 2> menu switch is set to "WARNING", a warning signal (+12 V) is output if an abnormality occurs in tape transport or mechanism operation.

• Recording mode signal output

When the <TERMINAL SEL 2> menu switch is set to REC and the unit is in the Record mode, the recording mode signal (+12 V) is output.

⑪ [COM] common ground terminal

Connect to the ground terminal of a connected unit.

⑫ [TAPE END OUT] tape end signal output terminal

Outputs a Tape End signal when the tape ends during recording.

• Outputs a +12 V signal during recording, playback, FF and rewind. When the tape ends during recording, a 0 V (GND level) signal is output.

• When the tape ends during auto repeat recording, signals are output for about 2 seconds.

• Connect an external alarm lamp or buzzer via an external interface.

• To cancel the output, press the EJECT button, PLAY button, FF button or REW button.

The timing of the tape end signal output during recording can be selected with the <REC REMAIN> menu switch (at tape end, or 3 minutes or 6 minutes before the tape ends).

⑬ [ALARM REC OUT] alarm recording mode signal output terminal

Outputs +12 V signals during alarm recording.

⑭ [ALARM RESET] alarm signal reset input terminal

Receives signals to cancel alarm recording.

• Alarm input data is not reset.

⑮ [ALARM IN] alarm signal input terminal

Receives signals to start alarm or sensor recording.

⑯ [COM] common ground terminal

Connect to the ground terminal of a connected unit.

⑰ [CAM SW OUT] camera switching signal output terminal

When a sequential switcher is connected, this terminal outputs camera switching timing control signals. For details, refer to page 54.

3 CONNECTIONS

3-1 Connecting to a Camera

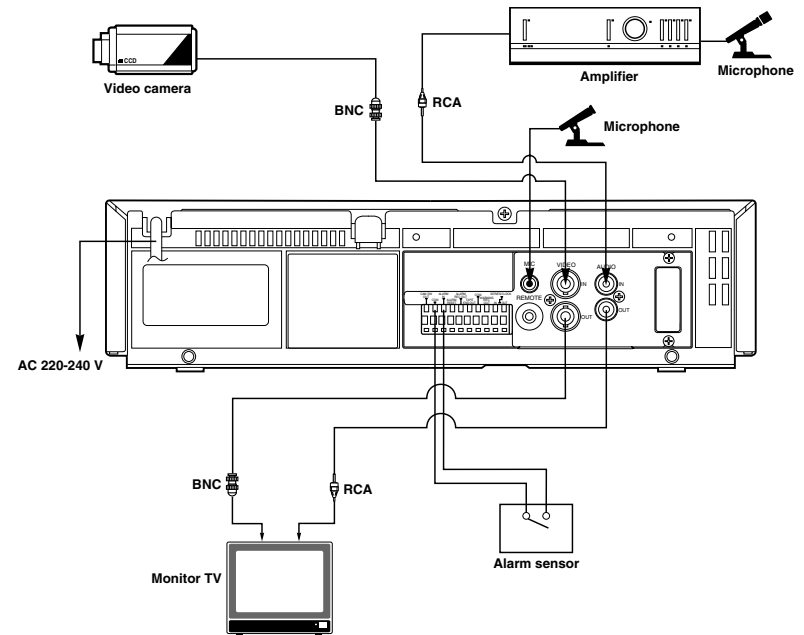

- 1 Connect the monitor's video/audio input connectors to the SR-L910E/EK's video/audio output connectors.
- 2 Connect the video camera's video output connector to the SR-L910E/EK's video input connector.
- 3 Input audio signals to the audio input connectors via an amplifier.
- 4 When connecting an alarm sensor, connect it to the SR-L910E/EK's alarm input terminal.
- 5 When the connection is complete, connect the power plug to an AC 220-240 V, 50/60 Hz outlet.

CONNECTION TO THE SW-501E/SW-502E SEQUENTIAL SWITCHER

SW-501E/SW-502E JK102/JK202	
① D.GND	-
② AT 1	IN
③ AT 0	OUT
④ CS1 0	IN
⑤ CS0 1	OUT
⑥ TMP1	IN
⑦ SODT	IN/OUT
⑧ SLV/MST	IN

JK103/JK203	
① D.GND	-
② AT 0	OUT
③ AT 1	IN
④ CS0 1	OUT
⑤ CS1 0	IN
⑥ TMP0	OUT
⑦ SODT	IN/OUT
⑧ D. +5 V	OUT

Sequential switcher
SW-501E/SW-502E

1. Connect pin 6 on the sequential switcher's TIMER INPUT connector to the VCR's CAMERA SW OUT terminal. Connect pin 1 to the GND terminal.
2. Connect pin 8 on the sequential switcher's TIMER INPUT connector to pin 8 on its TIMER OUT connector.

Note:

- Be sure to use two DIN connectors for connections.
- Set the function menu switch <CAM SW WIDTH> to 5msec. (Factory setting: 5msec)

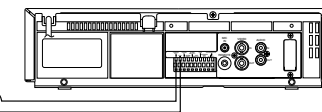

3 CONNECTIONS

3-2 Connecting a System Using a Sequential Switcher

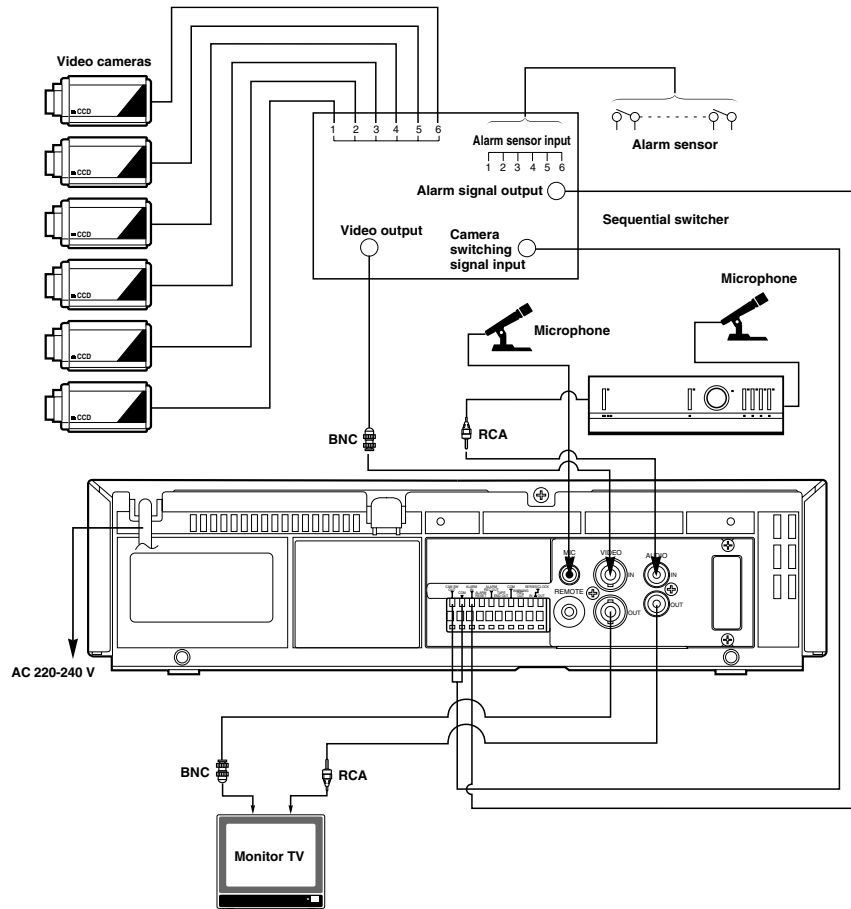

- 1 Connect video cameras and alarm sensor to a sequential switcher (frame switcher).
- 2 Connect the sequential switcher's (frame switcher) alarm signal output, camera switching signal input and video output to the SR-L910E/EK.
- 3 Connect the monitor's video/audio input connectors to the SR-L910E/EK's video/audio output connectors.
- 4 When the connection is complete, connect the power plug to an AC 220-240 V, 50/60 Hz outlet.
- 5 Synchro should be applied to all connected video cameras.

3 CONNECTIONS

3-3 Connecting the Rear Panel Input/Output Terminal Connections

[CAM SW OUT] camera switching signal output terminal

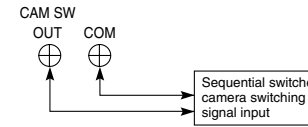

[ALARM IN] alarm signal input terminal

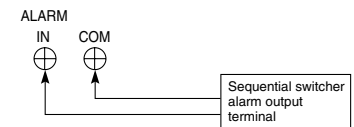

[ALARM RESET] alarm reset terminal

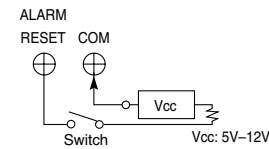

[ALARM REC OUT] alarm recording mode signal output terminal

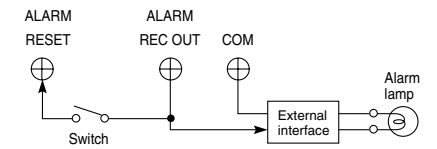

[TAPE END OUT] tape end output terminal

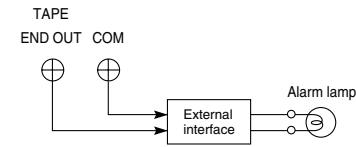

[WARNING/REC OUT] warning signal/recording mode signal output terminal

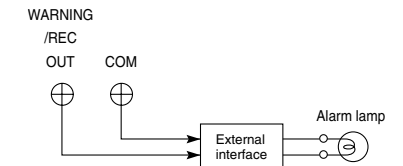

[CLOCK IN/OUT] clock reset terminal

- When setting the clock to the first VCR's clock

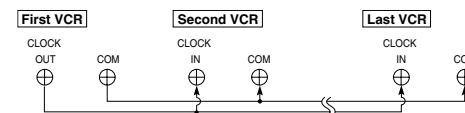

- When setting the clock to the external master clock

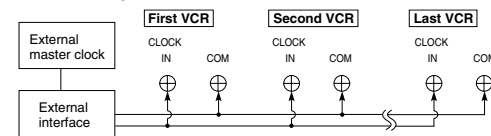

External interface example

Example: Lamp lights with HIGH signal

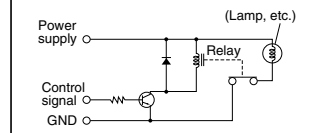

- Use appropriately rated devices.

4 MONITOR ON-SCREEN DISPLAY

Status information and other data including date/time, alarm input data, power loss (power failure) data and total operation hours can be displayed on a connected monitor. Function settings can be switched via the on-screen function menu switches and menu screens are also provided for timer recording program setting and date/time setting.

- Normally, the time/date data is shown on screen.
- Additional data displays and menu screens can be displayed by pressing the [MENU] button. This calls up the main menu screen where you can select items as desired.

4-1 On-Screen Display in the Time/Date and Record Modes

Time/date and recording mode data is recorded and displayed on screen.

In the Stop, Record and Record Pause modes, data is superimposed on the input video signals.

- The on-screen display can be switched ON/OFF using the <POSITION> switch in the function menu's ON SCREEN MODE setting screen. You can also change the on-screen display position using this switch.

Menu switch
<POSITION> setting

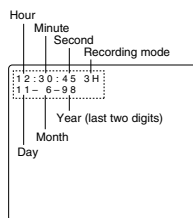

• "L-UP"

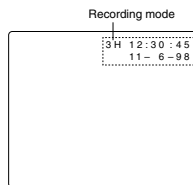

• "R-UP"

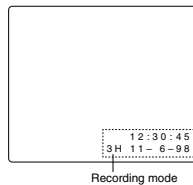

• "R-BOTTOM"

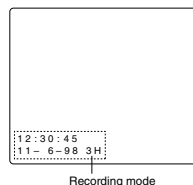

• "L-BOTTOM"

Display

- Connect the VCR's video output connector to the monitor's video input connector.
- 1 Turn the power on (monitor and VCR) and engage the Stop mode.
- 2 When a video signal is input to the video input connector, time/date, and recording mode are superimposed on the picture.
- If there is no signal input, display data is superimposed on a black background.

* If the date and time have not been set, correct date and time indications are not available.

- If no on-screen data is displayed, set the <POSITION> menu switch in the function menu's ON SCREEN MODE setting screen to the desired position (except "OFF").

- Changing the display position
You can select the position on screen where data is displayed with the <POSITION> menu switch in the ON SCREEN MODE setting screen. Data can be displayed in any one of the four corners of the screen.

Setting of the menu switch <POSITION>

- L-UP : Left top (factory setting)
- R-UP : Right top
- R-BOTTOM : Right bottom
- L-BOTTOM : Left bottom
- OFF : Display is off. No indications are shown.

- For "Function menu switch setting", refer to page 19.

- In the Record mode, on-screen time/date and recording mode data is recorded together with video signals.
If you do not want to record on-screen data, set the <POSITION> menu switch to "OFF".
- In the Play mode, on-screen data recorded on the tape is displayed.

4 MONITOR ON-SCREEN DISPLAY

4-2 Main Menu Display

You can display date and time data recorded when an alarm input or power failure occurs, as well as the hour meter (drum rotating time) by selecting the desired item in the main menu.

The timer recording program setting screen, function menu switch setting screen, and date/time setting screen can also be displayed by selecting the desired item in the main menu.

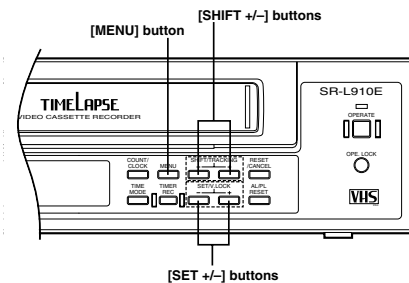

Main menu screen

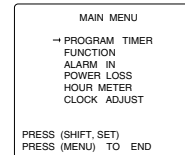

- PROGRAM TIMER:
Displays the program setting screen for timer recording.

* Timer programming is not possible if the date and time are not set. In this case, the date/time setting screen will be displayed.

- FUNCTION:
Displays the function menu setting screen.
- ALARM IN:
Displays the date and time when an alarm signal was input.
- POWER LOSS
Displays the date and time when a power failure occurred.
- HOUR METER:
Displays the hour meter (drum rotating time).
- CLOCK ADJUST:
Displays the date/time setting screen.
* Set the date and time before using this unit.

Operation

- Connect the VCR's video output connector to the monitor's video input connector.
- 1 Turn on the VCR and the monitor. Make sure the Stop mode is engaged.
- 2 Press the [MENU] button.
→ The main menu screen is displayed.
- 3 Press the [SHIFT +/-] button to move the cursor arrow to the item you want to display.
 - Press the [SHIFT +] button to move the cursor arrow down. Press the [SHIFT -] button to move it up.
- 4 Press the [SET +] or [SET -] button to display the selected item.
- 5 To end menu operation and restore the normal screen, press the [MENU] button.

- When the [MENU] button is pressed during playback, the monitor screen display switches from the playback picture to the input video signal (EE picture) and the main menu is shown on the screen.
This means that even during playback you can check menu contents. Press the [MENU] button again to restore the playback picture.

4 MONITOR ON-SCREEN DISPLAY

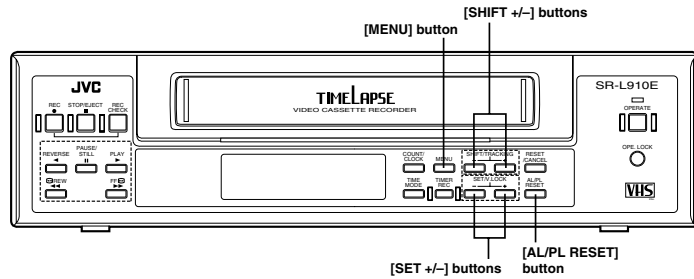

4-3 Alarm Input/Power Loss Data Display

The dates and times of up to nine (9) alarm inputs or power losses (failures) can be displayed.

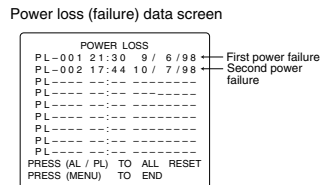
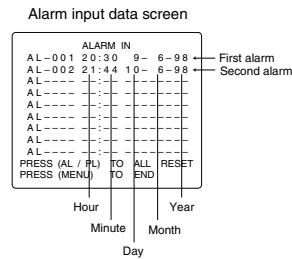

4-4 Hour Meter Display

Drum rotating time is displayed in the form of an hour meter. Use this data to schedule maintenance.

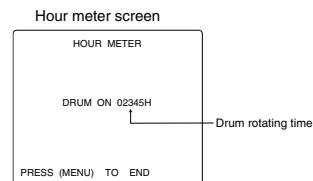

- 1 Turn on the VCR and monitor. Make sure the Stop mode is engaged.
- 2 Press the [MENU] button to display the main menu.
- 3 Press the [SHIFT +] or [SHIFT -] button to select ALARM IN or POWER LOSS.
 - To display alarm input data, select ALARM IN. To display power failure data, select POWER LOSS.
- 4 Press the [SET +] or [SET -] button to display the selected data (alarm input or power loss).
 - When 10 or more alarm input or power loss data items have been stored, subsequent data will replace earlier items, beginning from the second item.
- 5 Press the [MENU] button to end menu operation and restore the normal screen.

Resetting alarm input/power loss (failure) data

When the "AL" (alarm) display is off and the VCR is in the normal screen mode, press the [AL/PL RESET] button to reset the alarm input and power loss data stored in memory.

Operation

- 1 Turn on the VCR and monitor. Make sure the Stop mode is engaged.
- 2 Press the [MENU] button to display the main menu.
- 3 Press the [SHIFT +] or [SHIFT -] button to select HOUR METER.
- 4 Press the [SET +] or [SET -] button to display the hour meter (drum rotating time).
- 5 Press the [MENU] button to end menu operation and restore the normal screen.

5 SETTING OF THE FUNCTION MENU SWITCHES

You can customize the VCR's functions to suit the requirements of your application using on-screen menu's function switches.

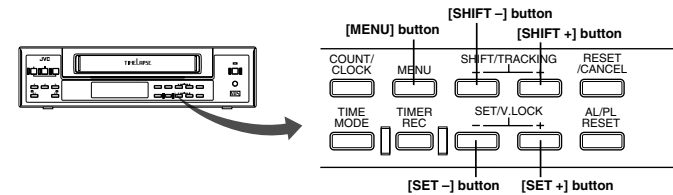

- Menu function switches are available on four setting screens: ON SCREEN MODE, VTR MODE 1, VTR MODE 2 and ALARM/SENSOR REC mode. (When the optional SA-K97U RS-232C interface board is installed, the RS-232C PARAMETER setting screen is also available.)

5-1 Function Menu Switch Setting

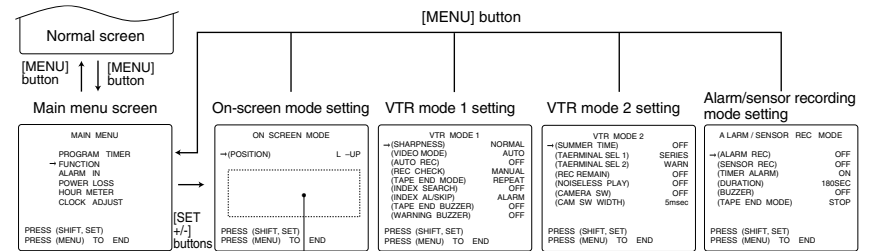

- When the optional SA-K97U RS-232C interface board is installed, the RS-232C PARAMETER setting screen is also available.

- Select an item with the [SHIFT +/-] buttons.
- Enter the selected values with the [SET +/-] buttons.

Preparation

- Connect the VCR's video output connector to the monitor's video input connector.
- Turn on the VCR and the monitor. Make sure the Stop mode is engaged.

- 1 Press the [MENU] button to display the main menu.
- 2 Press the [SHIFT +] or [SHIFT -] button to select FUNCTION.
- 3 Press the [SET +] or [SET -] button.
 - The ON SCREEN MODE setting screen is displayed.
 - Only one menu switch is available in the ON SCREEN MODE setting screen. This switch (<POSITION>) allows you to select the screen position of the on-screen display and to switch it ON/OFF.
- 4 Press the [SET +] or [SET -] button to enter the selected position.
- 5 To display another setting screen, press the [SHIFT +/-] button.
 - Press the [SHIFT +] button to display the VTR mode 1 setting screen.
 - Press the [SHIFT -] button to display the alarm/sensor recording mode setting screen.

- 6 The VTR mode 1, VTR mode 2 and alarm/sensor recording mode setting screens include several menu switches.

- Press the [SHIFT +] or [SHIFT -] button to select the item you want to set.

- When the cursor arrow reaches the last item (bottom of the screen) pressing the [SHIFT +] button advances the display to the next menu switch setting screen. e.g.: (WARNING BUZZER) → (SUMMER TIME)
- When the cursor arrow is at the first item (top of the screen), pressing the [SHIFT -] button will change the display to the previous menu switch setting screen. e.g.: (SHARPNESS) → (POSITION)

- 7 Press the [SET +] or [SET -] button to enter the selected value.

- To set more than one menu switch, repeat steps 6 and 7.

- 8 End menu switch setting. Press the [MENU] button twice.
 - The normal screen is restored.

- Set values are stored in the VCR's memory. This data is retained even when the power is turned off.

5 SETTING OF THE FUNCTION MENU SWITCHES

5-2 Contents of the Function Menu Switches

Three function menu switch setting screens are available.

[]: Factory setting

Screens	Items	Set values	Function
On-screen mode setting	POSITION	[L-UP] R-UP R-BOTTOM L-BOTTOM OFF	Sets the on-screen position of time/date and recording mode data. If no on-screen display is required, use this menu switch to turn it off. L-UP : Display is shown in the top left corner of the screen. R-UP : Display is shown in the top right corner of the screen. R-BOTTOM : Display is shown in the bottom right corner of the screen. L-BOTTOM : Display is shown in the bottom left corner of the screen. OFF : The on-screen display is not shown.
VTR mode 1 setting	SHARPNESS	[NORMAL] SHARP	Selects the picture quality in the Play mode. NORMAL : Normal picture quality. SHARP : Picture contours are emphasized.
	VIDEO MODE	[AUTO] B/W	Allows you to force Black and White recording regardless of the type of signal input. AUTO : Normally set to this mode. Recording automatically conforms to the type of signal input (Colour or Black and White). B/W : Even if a colour video signal is input, recording is performed in the Black and White mode. A higher resolution picture can be obtained than in the Colour mode.
	AUTO REC	[OFF] ON	Enables or disables automatic external timer recording or automatic restart of recording after a power failure. OFF : External timer recording or automatic recording after power failure is disabled. ON : Recording starts automatically when power is turned on.
	REC CHECK	[MANUAL] AUTO	Sets whether or not Recording Check is automatically performed at the beginning of a tape in the Repeat Recording mode. Also sets what action is taken if picture quality is found to be defective when Recording Check is activated with the [REC CHECK] button. MANUAL: <ul style="list-style-type: none"> If picture quality is found to be defective when Recording Check is activated with the [REC CHECK] button, head cleaning is performed once and recording resumes. The error indication "E-09" is shown on the display for 10 seconds. Automatic Recording Check is not performed at the beginning of a tape set to record repeatedly. AUTO: <ul style="list-style-type: none"> If picture quality is found to be defective when Recording Check is activated with the [REC CHECK] button, head cleaning is performed and recording resumes for several seconds, then the recording is automatically checked again. If the picture quality is still defective, head cleaning is performed again and the error indication "E-09" is shown on the display. The error indication remains displayed while recording continues. Automatic Recording Check is performed at the beginning of a tape set to record repeatedly. If the picture quality is defective, Recording Check is performed again. If the picture quality is still defective, head cleaning is performed again and the error indication "E-09" is shown on the display. The error indication remains displayed while recording continues.
	TAPE END MODE	[STOP] REW REPEAT EJECT	Sets the operation mode when the tape ends in the Record mode. (In the Play and FF modes, the tape stops.) STOP : The tape stops. REW : The tape automatically rewinds and enters the Stop mode. REPEAT : In the Record mode, the tape automatically rewinds and then restarts recording (repeat recording). EJECT : The tape is ejected. <div style="border: 1px solid black; padding: 5px; width: fit-content;"> The operation mode at tape end during recording, in the case when alarm or sensor recording is executed even once, can be set with the menu switch <TAPE END MODE> on the alarm/sensor recording mode setting screen. </div>

5 SETTING OF THE FUNCTION MENU SWITCHES

5-2 Contents of the Function Menu Switches

[]: Factory setting

Screens	Items	Set values	Function
VTR mode 1 setting	INDEX SEARCH	[OFF] ON	Enables or disables the Index Search function. OFF : The index search function is disabled. ON : When an index-recorded tape is put in the FF or REW Shuttle Search mode, the VCR searches for the nearest recorded index code (VISS signal) and engages playback at the indexed position. When an alarm-recorded tape is fast-forwarded or rewound, the VCR searches for the nearest index code and enters the Stop mode at the indexed position. Select whether the index signal is to be recorded during alarm signal input or every hour (exact hour with no minute and second) using the function menu switch <INDEX ALARM/SKIP>.
	INDEX AL/SKIP	[ALARM] SKIP	Sets the timing of the recording of the index code. ALARM : Index is recorded when the ALARM signal is input. SKIP : Index is recorded with 1-hour intervals.
	TAPE END BUZZER	[OFF] ON	Turns the Tape End buzzer on or off. OFF : The buzzer does not sound at tape end. ON : When the tape reaches the position set with the <REC REMAIN> menu function switch during recording (tape end, or 3 minutes or 6 minutes before the tape ends), a buzzer sounds. To stop the buzzer sound, press the [REW] button, [EJECT] button or [POWER] button. When the mode is changed, the buzzer sound stops.
	WARNING BUZZER	[OFF] ON	Turns the warning buzzer on or off. OFF : The buzzer does not sound. ON : The buzzer sounds.
VTR mode 2 setting	SUMMER TIME	[OFF] ON	Turns summer time compensation on or off. OFF : Clock is not adjusted for summer (daylight saving) time. ON : Clock is adjusted for summer (daylight saving) time.
	TERMINAL SEL 1	[SERIES] EXT C.ADJ	Select the signal to be input or output to the [SERIES/CLOCK IN-OUT] terminals on the rear panel. SERIES : Set to this position to input or output a series recording signal. EXT : Set to this position to start or stop the recording with the VCR activation signal input from an external control device. C.ADJ : Set to this position to input or output a clock reset signal.
	TERMINAL SEL 2	[WARN.] REC	Select the signal output from the rear panel's [WARNING/REC OUT] terminal. WARN. : Set to this position to output a warning signal. The warning signal is output if an abnormality occurs in tape transport or mechanism operation. REC : Set to this position to output a recording mode signal (+12 V) in the Record mode.
	REC REMAIN	[OFF] 180S 360S	Set the tape end signal output timing. When the tape reaches the specified position, the following signals are output. <ul style="list-style-type: none"> The tape end signal is output from the rear panel's [TAPE END] terminal. The series recording signal is output from the rear panel's [SERIES OUT] terminal (with the <TERMINAL SEL 1> function menu switch set to "SERIES"). The tape end buzzer sounds (with the <TAPE END BUZZER> function menu switch set to "ON") • "End" is shown on the counter display. OFF. : When the tape ends 180S. : When the tape remaining time is about 3 minutes 360S : When the tape remaining time is about 6 minutes
	NOISELESS PLAY	[OFF] ON	Sets the tape transport for 12H and 24H Timelapse mode. OFF : Linear tape transport in the 12/24H PLAY mode. However, the FDP display becomes L12H/L24H. ON : Frame tape transport in the 12/24 H PLAY mode. However, the FDP display becomes 12H/24H.

5 SETTING OF THE FUNCTION MENU SWITCHES

5-2 Contents of the Function Menu Switches

[] : Factory setting

Screens	Items	Set values	Function
VTR mode 2 setting	CAMERA SW	[OFF] 1 FIELD 1 FRAME	Sets the camera switching interval for output to an external sequential switcher during recording. OFF : No camera switching signal is output. 1 FIELD : Set to this position to switch the camera every 1 field. 1 FRAME: Set to this position to switch cameras every 1 frame.
	CAM SW WIDTH	[5 msec] 20 msec	Sets the output time of the camera switching signal. 5m sec : Camera switching signal output time for 3/12/24H recording : 5 msec. 20m sec : Camera switching signal output time for 3H recording : 5 msec. 12/24H recording : 20 msec.
Alarm/sensor recording mode setting	ALARM REC	[OFF] ON	Turns the alarm recording function on or off. Alarm recording is enabled only in the Timelapse Record mode. An index code (VISS signal) is also recorded at the start point of alarm recording as an alarm cue signal. OFF : Alarm recording is disabled. ON : This unit enters the VHS SP Record mode, when an alarm signal is input to the rear panel's [ALARM IN] terminal during timelapse recording.
	SENSOR REC	[OFF] ON	Turns the sensor recording function on or off. Sensor recording is enabled in the Stop mode. An index code (VISS signal) is also recorded at the start point of sensor recording. OFF : Sensor recording is disabled. ON : When an alarm signal is input to the rear panel's [ALARM IN] terminal in the Stop mode, this unit automatically starts recording in the VHS SP Record mode.
	TIMER ALARM	OFF [ON]	Sets whether or not the alarm signal input should be enabled during timer recording. OFF : Alarm signal input during timer recording is disabled. ON : Alarm signal input during timer recording is enabled.
	DURATION	5 15 30 60 120 [180] TAPE END MANUAL	Selects the recording duration for alarm recording or sensor recording. 5 180 : Alarm or sensor recording is performed for the time specified (5 sec. to 180 sec.). TAPE END: Alarm or sensor recording continues until the tape ends. MANUAL : Alarm or sensor recording continues for as long as alarm signals are input. Set to this position when specifying the alarm recording time with a switcher.
	BUZZER	[OFF] ON	Selects whether or not the alarm buzzer sounds during alarm or sensor recording. OFF : The buzzer does not sound. ON : The buzzer sounds.
	TAPE END MODE	[STOP] REW REPEAT EJECT	Set the operation mode at tape end during recording in the case when alarm or sensor recording is executed even once. STOP : Stops at tape end. REW : Rewinds the tape automatically and stops. REPEAT : Rewinds the tape automatically to the beginning and restarts recording. EJECT : The tape is ejected.
RS-232C parameter setting	This screen is displayed on the on-screen setting screen only when the (optional) RS-232C board SA-K97U is installed.		
	BAUD RATE	1200 2400 4800 [9600]	Select the RS-232C data transfer speed from 1200 bps, 2400 bps, 4800 bps or 9600 bps.

6 PREPARATION

6-1 Cassette Loading/Unloading

Loading

Insert the cassette with its label side facing you.
Gently push the center of the cassette until the machine starts automatic loading.

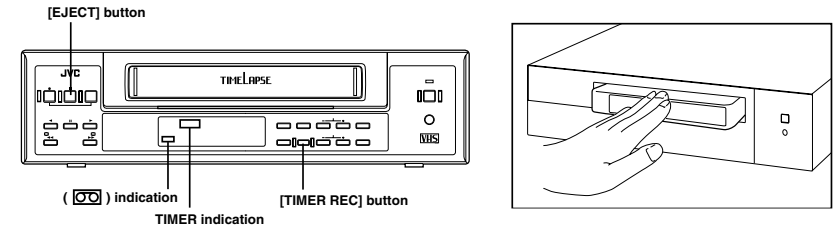

Note:
To avoid damage or injury, do not insert your hand or other foreign objects into the cassette loading slot.

Auto power on

When a cassette is loaded, the power automatically turns on and the () cassette indication appears.

Auto play

When a cassette with no erasure prevention tab is loaded, playback starts automatically.

Unloading

■ Press the [EJECT] button.
→ The cassette is ejected.
If the power is not on when the [EJECT] button is pressed, power is automatically switched on and the cassette is ejected. Once the cassette is unloaded, the power turns off again automatically.

If the Timer Recording Standby mode is engaged (TIMER indication is shown on the display), the cassette will not be ejected when the [EJECT] button is pressed.
To unload the cassette, press the [TIMER REC] button to release the Timer Recording Standby mode, then press the [EJECT] button.

6-2 Date and Time Setting

The time/date generator and timer recording will not function if the date and time are not set.
The time/date setting can be enabled on the CLOCK ADJUST menu screen or the front panel display.

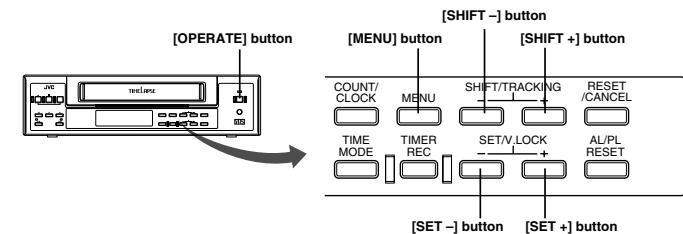

- Time-keeping continues even when the power cable is unplugged from the AC outlet or a power failure occurs.
- If the power cable has been unplugged for a long time of period, check the current time before using the VCR. (Time shift may occur under certain operating or environmental conditions.)

6 PREPARATION

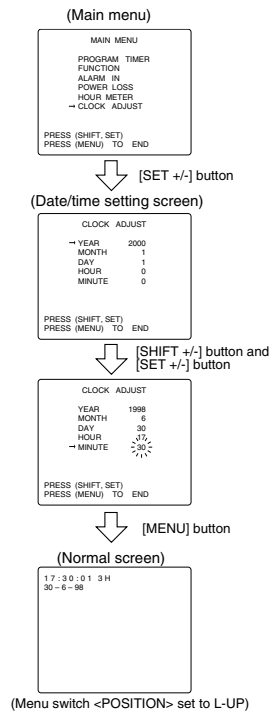

Set the date and time using the CLOCK ADJUST menu screen.

- Turn on this unit and the monitor and engage the Stop mode.
 - Press the [MENU] button to display the main menu screen.
 - Press the [SHIFT +] or [SHIFT -] button to select <CLOCK ADJUST>. (Set the cursor arrow to <CLOCK ADJUST>.)
 - Press the [SET +] or [SET -] button to display the CLOCK ADJUST screen on the monitor.
 - Select the item to be set.
 - Press the [SHIFT +] or [SHIFT -] button to select the item.
 - The selected item will blink.
 - Enter the value for the selected item with the [SET +/-] button.
 - Press the [SET +] button to increase the number.
 - Press the [SET -] button to decrease the number.
- The setting range for the year is from 1997 to 2096.
 - This VCR uses the 24-hour clock.
 - If an invalid date is set, it is automatically corrected. (e.g.) 1999-2-29 → 1999-2-28
- Repeat steps 5 and 6 until the year, month, date, hour, and minutes have all been set.
- End date and time setting.
 - Press the [MENU] button twice.
 - The normal display is restored and the set date and time are shown on screen. The time count starts from 00 seconds.

Note:

- If you press the [OPERATE] button after setting the date and time without first pressing the [MENU] button, the set date and time are canceled.

Set the date and time on the front panel display

- Turn the power on.
- Press the [COUNT/CLOCK] button for at least 2 seconds.
 - The "year" indication blinks in the display.
- Enter the value for the year with the [SET+] or [SET-] button.
- Press the [SHIFT+] button: the "month" indication blinks.
 - Press the [SHIFT+] or [SHIFT-] button to move the blinking section.
 - Enter the value for the blinking section with the [SET+] or [SET-] button.
- Set the "month", "day", "hour" and "minute" with the [SHIFT +/-] and [SET +/-] buttons.
- When you have finished setting, press the [COUNT/CLOCK] button.
 - The display returns to the clock display mode and the time count starts from 00 seconds.

Time indication on the VCR's display

- When the power is turned off, the time is displayed. When the power is turned on, set the time display mode with the [COUNT/CLOCK] button to display the current time.
- The first time you turn on the power, the time display shows a blinking "0:00:00".
- When the built-in backup battery capacity is low, the error indication E-10 appears on the display. Contact your local JVC dealer to replace the built-in battery.

6 PREPARATION

6-3 Summer Time Compensation

Set whether or not the Summer Time mode is engaged with the <SUMMER TIME> function menu switch on the VTR mode 2 setting screen. When the <SUMMER TIME> switch is set to "ON", the currently set time is advanced one hour.

- When setting the time, make sure the <SUMMER TIME> switch is set to "OFF". When the unit is shipped, this switch is set to "OFF".
- Clock setting is not possible during timer recording.

During daylight savings time

- Set the time with one-hour delay.
- After setting the time, set the <SUMMER TIME> switch to "ON".
 - The set time advances one hour.
- At the end of the daylight savings time season, set the <SUMMER TIME> switch to OFF.
 - The standard time instead of "Summer Time" is displayed.

Standard time

- Set the clock to the actual time.
- When daylight savings starts, set the <SUMMER TIME> menu switch to "ON".
 - The time advances one hour on the display

6-4 Selection of Record/Play Mode

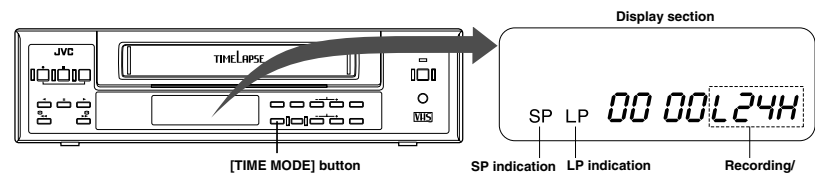

- Press the [OPERATE] button to turn the operating mode on. The [OPERATE] indicator lights.
- Select the recording/playback time mode with the [TIME MODE] button. Refer to the table below for more information on each mode.
 - Each time the [TIME MODE] button is pressed, the recording mode changes in the following order: 3H (VHS SP mode) → L12H (12-hour Timelapse mode) → L24H (24-hour Timelapse mode) → 3H (VHS SP mode) ... Playback Time Mode will differ depending on how the function menu switch <NOISELESS PLAY> is set. When NOISELESS PLAY is set to OFF: 3H (VHS SP mode) → L12 (12-hour Timelapse mode) → L24 (24-hour Timelapse mode) → 3H (VHS SP mode) ... When NOISELESS PLAY is set to ON: 3H (VHS SP mode) → 12 (12-hour Noiseless playback mode) → 24 (24-hour Noiseless playback mode) → 3H (VHS SP mode) ...
 - The selected recording or playback time mode is shown on the display.
 - The SP indicator lights.

Note:

- When a tape recorded in the VHS Long Play (LP) mode is played back, the LP indicator lights. Recording in the LP mode is not possible with this unit.

Display indications	Modes	Available recording time (hour)					Recording/playback interval (sec.)	Audio recording	Tape running
		E-30	E-60	E-90	E-120	E-180			
3H	VHS Standard (SP)	0.5	1	1.5	2	3	—	Possible	(Continuous) 23.39 mm/sec.
L12H	12-hour Timelapse	2	4	6	8	12	0.1	Possible	(Continuous) 4.68 mm/sec.
L24H	24-hour Timelapse	4	8	12	16	24	0.18	Possible	(Continuous) 2.60 mm/sec.
12H	12-hour Noiseless	2	4	6	8	12	0.1	Impossible	Continuous field advance
24H	24-hour Noiseless	4	8	12	16	24	0.18	Impossible	Continuous field advance

* Recording time varies depending on the type of cassette used.

* For optimum performance and reliability, use a tape with a standard recording time of 180 minutes (E-180) or less.

* You can set 12H and 24H only during Playback Mode.

7 RECORDING

7-1 Preparation

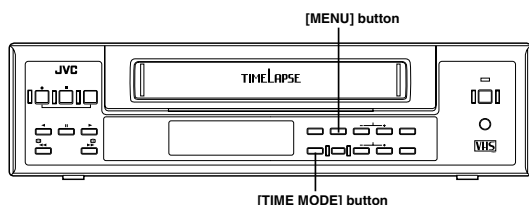

Connection

Make sure the input/output connectors on the rear panel are properly connected. For details, refer to "CONNECTIONS" on page 13 to 15.

Menu switch setting

Set the function menu switches as required.

- **<POSITION> ... Factory setting: L-UP**
 - Sets the position of the on-screen time/date and recording mode display. Select one of the four corners of the screen. During recording, the on-screen data is recorded in the selected position together with the video signals.
 - If on-screen data recording is not required, set this switch to OFF.
- **<VIDEO MODE> ... Factory setting: AUTO**
 - Set to "B/W" to record colour video signals in the Black and White mode.
- **<AUTO REC> ... Factory setting: OFF**
 - Set to ON to execute timer recording using a commercially available external timer or to automatically resume recording when power is restored after a power failure.
 - For details, refer to "How To Restore Recording After Power Failure" and "External Timer Recording" on page 39.
- **<REC CHECK> ... Factory setting: MANUAL**
 - Selects between manual and automatic Recording Check operation.
 - When set to AUTO, Recording Check is automatically executed at the beginning of a tape set to record repeatedly or when inferior picture quality is detected. In the Auto mode, Recording Check and head cleaning is automatically repeated up to two times. If the inferior picture quality is detected on both checks, the warning code E-09 is displayed. The warning code remains displayed while recording continues.
 - When set to MANUAL, the Recording Check operation is executed only when the [REC CHECK] button is pressed. If inferior picture quality is detected, head cleaning is performed once and recording resumes. The warning code "E-09" is shown on the display for 10 seconds.
- **<TAPE END MODE> ... Factory setting: STOP**
 - Selects the mode engaged when the tape ends during recording.
 - When set to STOP, the Stop mode is engaged.
 - When set to REW, the tape is rewound to the beginning.
 - When set to REPEAT, the tape is rewound to the beginning and recording re-starts (repeat recording).
 - When set to EJECT, the tape is ejected.
- **<INDEX AL/SKIP> ... Factory setting: ALARM**
 - Sets the timing for recording of the index code. When set to "ALARM", the code is recorded at the time of the alarm signal input.
 - When set to "SKIP", it is recorded once each hour during the actual duration of the recording. (This is unrelated to the recording mode time.)
- **<TAPE END BUZZER> ... Factory setting: OFF**
 - Set to ON to sound the buzzer when the tape ends during recording.
- **<TERMINAL SEL 1> ... Factory setting: SERIES**
 - Set the rear panel's [SERIES/CLOCK] terminal as required.
 - Set to "SERIES" when to use the series recording function.
 - Set to "EXT" when to control recording start/stop from an external device.
- **<TERMINAL SEL 2> ... Factory setting: WARN**
 - Select the signal output from the rear panel's [WARNING/REC OUT] terminal.
 - Set to WARN to output a warning signal.
 - Set to "EXT" to output a recording mode signal (+12 V) during recording.
- **<REC REMAIN> ... Factory setting: OFF**
 - Select the timing to send the tape end information. Choose from tape end (OFF), about 3 minutes before the tape end (180S) or about 6 minutes before the tape end (360S). When the tape reaches the selected position during recording, the following information is output.
 - Tape end signal from the rear panel's [TAPE END OUT] terminal
 - Series recording signal during series recording
 - Tape end buzzer
 - "End" indication in the counter display
- **<CAMERA SW> ... Factory setting: OFF**
 - Sets the switching timing for cameras connected to an external sequential switcher.
 - To switch cameras after each field or frame, set this menu switch to FIELD or FRAME.
- **<CAM SW WIDTH> ... Factory setting: 5 msec**
 - Sets the output time for the camera switching signal to be output to the external sequential switcher during recording. When set to "5msec", the output time becomes 5 msec in the 3/12/24H recording mode. When set to "20msec", the output time becomes 20 msec in the 3H recording mode, and 20 msec in the 12/24H recording mode.
- **<ALARM REC> ... Factory setting: OFF**
 - Set to ON to perform alarm recording. For details, refer to "Alarm Recording" on page 33.
- **<SENSOR REC> ... Factory setting: OFF**
 - Set to ON to perform sensor recording. For details, refer to "Sensor Recording" on page 35.
- **<TIMER ALARM> ... Factory setting: ON**
 - Sets whether or not the alarm signal input should be enabled during timer recording. When set to "OFF", alarm signal input is disabled, and when set to "ON", the alarm signal input is enabled.

Setting on the front panel

- Select the recording time mode with the [TIME MODE] button. For details, refer to "Selection of the Record/Play mode" on page 25.

7 RECORDING

7-2 Recording

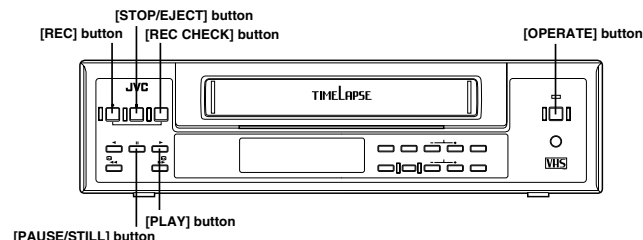

- 1 Press the [OPERATE] button to turn the operating mode on.
 - The [OPERATE] indicator lights.
- 2 Insert a cassette with safety tab in place.
 - The () cassette indication lights on the display.
 - * If a cassette is loaded when the operating mode is off, the operating mode is switched on automatically (auto operate on function).
- 3 Press the [REC] button to start recording.
 - The recording indicator lights on the display, showing that the Record mode is engaged.

To stop recording temporarily

- 4 Press the [PAUSE/STILL] button.
 - The record-pause indicator is shown on the display and the Pause mode is engaged.

To start recording again

- 5 Press the [PLAY] button.
 - The recording indicator is shown on the display and the Recording mode is engaged.

Note

If the VCR is left in the Record Pause mode for more than 5 seconds, the transition between scenes may be distorted when recording is re-started.

To stop recording

- 6 Press the [STOP/EJECT] button.
 - The tape stops and the Stop mode is engaged.

Recording Check

Record Check in the Timelapse mode should be performed after recording has been executed for more than one minute. If the recording time is too short, Record Check cannot be performed correctly.

- **Press the [REC CHECK] button during recording.**
 - The tape is played back in reverse for about 4 seconds, then, the Play mode is engaged to check the recording. After playback, the VCR enters the Record mode at the point where the recording was interrupted.
 - During Recording Check, the FM level of the signal recorded on the tape is checked in the Play mode to determine whether or not the recording quality is suitable. If the recording quality is judged inferior, subsequent operation depends on the setting of the <REC CHECK> function menu switch.

● When set to MANUAL

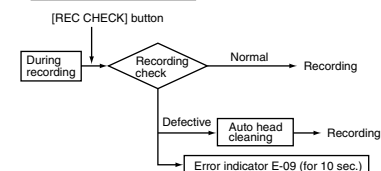

● When set to AUTO

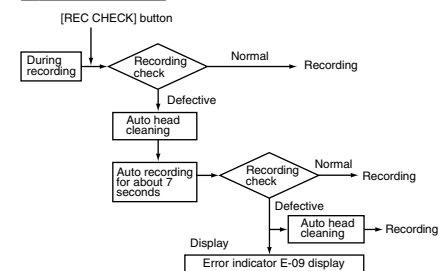

7 RECORDING

7-3 Timer Recording

Two types of timer recording are available: daily timer (by specifying the date) and weekly timer (by specifying the day of the week).

- Daily timer : Set the date to any date within one year of the current date. Up to 8 programs can be set.
- Weekly timer : Set the day of the week. Recording will automatically be performed on that day each week.

You can program the timer using the on-screen menu display.

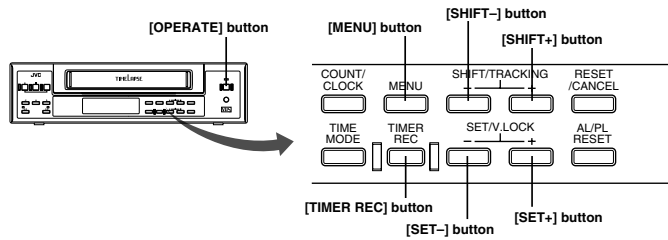

Note:

- Timer programming is not possible if the date and time have not been set.

Preparation

- Make sure all necessary equipment is properly connected to the input/output connectors on the rear panel.
- Check the current time.
- Load a cassette with the safety tab in place. If the power is off, loading the cassette automatically turns the VCR on (auto power on function).

Main menu screen

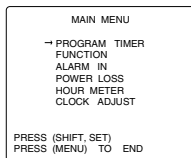

Daily timer program setting screen

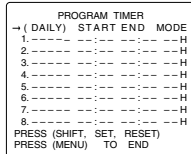

Weekly timer program setting screen

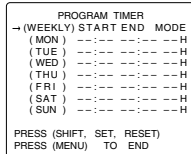

Setting the daily timer

- 1 Turn on this unit and the monitor and engage the Stop mode.
- 2 Press the [MENU] button.
→ The main menu screen is displayed on the monitor.
- 3 Press the [SHIFT +] or [SHIFT -] button to move the cursor arrow to <PROGRAM TIMER> in the main menu, then press the [SET +] or [SET -] button.
→ The daily timer program setting screen is displayed.

- <DAILY> is shown on the second line of the daily timer program setting screen.

• If the date and time have not been set, the date and time setting screen will be shown. Once the correct date and time have been set, repeat steps 2 and 3.

- When the weekly timer program setting screen is displayed, <WEEKLY> is shown on the second line.
- Press the [SHIFT +] or [SHIFT -] button to set the cursor arrow to <WEEKLY> and press the [SET +/] or [SET -] button.
→ The daily timer program setting screen is displayed.

7 RECORDING

7-3 Timer Recording

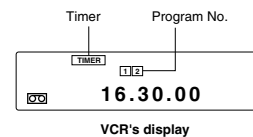
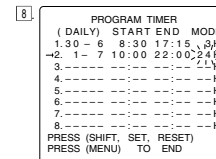
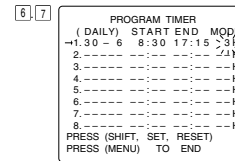
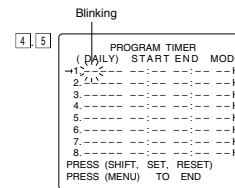
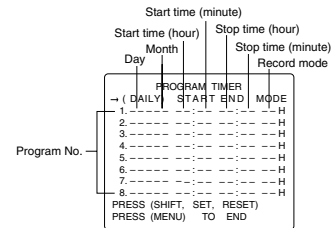

- 4 Select the timer program No.
Press the [SHIFT +] or [SHIFT -] button to move the cursor arrow to the program No. to be set.
• Press the [SHIFT +] button to move the cursor arrow down and the [SHIFT -] button to move it up.

- 5 Set the selected program No.
Press the [SET +] or [SET -] button.
→ The selected program No. blinks.
• Press the [SET +] button. The day blinks.
• Press the [SET -] button. The record mode blinks.

- 6 Set the timer.
① Press the [SHIFT +] or [SHIFT -] button until the item you want to set starts blinking.
• Press the [SHIFT +] button to shift the blinking to the right.

"Day" → "Month" → "Start time (hour)" → "Start time (minute)" → "Stop time (hour)" → "Stop time (minute)" → "Record mode" → Select the next program No.

- Press the [SHIFT -] button to move the blinking to the left.
- ② Press the [SET +] or [SET -] button to set the value for the blinking item.
• Press the [SET +] button to increase the value and the [SET -] button to decrease it.

- Set the "Day", "Month", "Start time (hour)", "Start time (minute)", "Stop time (hour)", "Stop time (minute)" and "Record mode" with the [SHIFT +/-] and [SET +/-] buttons.

→ When all values are set, the set program No. is shown on the VCR's display.

7 Accessing another program No.

- Select the "Record mode" (so that it is blinking) and press the [SHIFT +] button. Or, select "Day" (so that it is blinking) and press the [SHIFT -] button.
→ The selected item stops blinking. You may now select another program No.

- 8 To set more than one daily timer program, repeat steps 4 to 7.

• To program the timer to record once a week indefinitely, move the cursor arrow to the second line <DAILY> and press the [SET +] or [SET -] button. (For details, refer to page 30.)

- 9 To end timer programming, press the [MENU] button twice.

- The normal screen is restored.
- Press the [TIMER REC] button.

→ • The [TIMER] indication and the daily timer program numbers light in the VCR's display. Power is switched off automatically and the VCR enters the Timer Record Standby mode.
• During timer recording, the number of the daily timer program currently being executed blinks.

7 RECORDING

7-3 Timer Recording

Daily timer program setting screen

PROGRAM TIMER			
(DAILY)	START	END	MODE
1.	----	----	----
2.	----	----	----
3.	----	----	----
4.	----	----	----
5.	----	----	----
6.	----	----	----
7.	----	----	----
8.	----	----	----

PRESS (SHIFT, SET, RESET) TO END
PRESS (MENU) TO END

- Set the cursor arrow to the second line <DAILY> and press the [SET +/-] button.

Weekly timer program setting screen

Days of the week (Monday to Sunday)	Start time (hour)		Stop time (hour)		Record mode
	Start time (minute)	Stop time (hour)	Stop time (minute)	Record mode	
PROGRAM TIMER					
(WEEKLY)	START	END	MODE		
(MON)	----	----	----		
(TUE)	----	----	----		
(WED)	----	----	----		
(THU)	----	----	----		
(FRI)	----	----	----		
(SAT)	----	----	----		
(SUN)	----	----	----		

PRESS (SHIFT, SET, RESET) TO END
PRESS (MENU) TO END

Blinking

2, 3

PROGRAM TIMER			
(WEEKLY)	START	END	MODE
(MON)	----	----	----
(TUE)	----	----	----
(WED)	----	----	----
(THU)	----	----	----
(FRI)	----	----	----
(SAT)	----	----	----
(SUN)	----	----	----

PRESS (SHIFT, SET, RESET) TO END
PRESS (MENU) TO END

4, 5

PROGRAM TIMER			
(WEEKLY)	START	END	MODE
(MON)	8:30	19:30	2H
(TUE)	8:30	19:30	3H
(WED)	8:30	17:30	3H
(THU)	8:30	19:30	3H
(FRI)	8:30	22:30	2H
(SAT)	10:00	22:00	2H
(SUN)	----	----	----

PRESS (SHIFT, SET, RESET) TO END
PRESS (MENU) TO END

6

PROGRAM TIMER			
(WEEKLY)	START	END	MODE
(MON)	8:30	19:30	12H
(TUE)	8:30	19:30	12H
(WED)	8:30	17:30	3H
(THU)	8:30	19:30	3H
(FRI)	8:30	22:30	2H
(SAT)	10:00	22:00	2H
(SUN)	----	----	----

PRESS (SHIFT, SET, RESET) TO END
PRESS (MENU) TO END

Timer

TIMER

16.30.00

VCR's display

Setting the weekly timer

You can program the VCR to record on a specified day each week.

- Using the same procedure as in daily timer program setting, select <PROGRAM TIMER> in the main menu to display the timer program setting screen on the monitor. (Refer to steps 1 to 3 in daily timer programming.)

- When the timer program setting screen is displayed, the daily timer program setting screen is shown first.

- Display the weekly timer program setting screen. (<WEEKLY> is shown on the second line.)
 - Press the [SHIFT +] or [SHIFT -] button to move the cursor arrow to <DAILY> and press the [SET +] or [SET -] button.
 - The weekly timer program setting screen is shown. Select the day of the week you want to record on. Press the [SHIFT +] or [SHIFT -] button to set the cursor arrow to the day of the week to be set.
 - Press the [SHIFT +] button to move the cursor arrow down and the [SHIFT -] button to move it up.
- Set the selected day of the week blinks.
 - Press the [SET +] or [SET -] button.
 - The selected day of the week blinks.
 - Press the [SET +] button. The start time (hour) blinks.
 - Press the [SET -] button. The record mode blinks.

Set the timer.

- Press the [SHIFT +] or [SHIFT -] button until the item you want to set starts blinking.
 - Press the [SHIFT +] button to shift the blinking to the right.
 - "Start time (hour)" → "Start time (minute)" → "Stop time (hour)" → "Stop time (minute)" → "Record mode" → Select the next program No.
 - Press the [SHIFT -] button to move the blinking to the left.

- Press the [SET +] or [SET -] button to set the value for the blinking item.
 - Press the [SET +] button to increase the value and the [SHIFT -] button to decrease it.
- Set the "Start time (hour)", "Start time (minute)", "Stop time (hour)", "Stop time (minute)" and "Record mode" with the [SHIFT +/-] and [SET +/-] buttons.
 - When all values are set, the set program No. is shown on the VCR's display.

- Accessing another day of the week.
 - Select the "Record mode" (so that it is blinking) and press the [SHIFT +] button. Or, select "Start time" (so that it is blinking) and press the [SHIFT -] button.
 - The blinking part stops blinking. You may now select another day of the week.

- To set more than one weekly timer program, repeat steps 2 to 5.

- To end timer programming, press the [MENU] button twice.
 - The normal screen is restored.

- Press the [TIMER REC] button.
 - The [TIMER] indication lights in the VCR's display. Power is switched off automatically and the VCR enters the Timer Record Standby mode.

7 RECORDING

7-3 Timer Recording

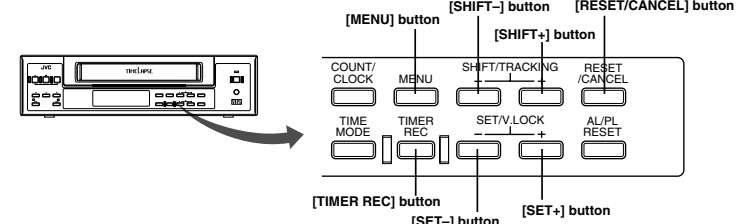

Alarm input during timer recording

- If you wish to allow alarm input during timer recording, turn the function menu switch <TIMER ALARM> to ON. (Factory setting: ON)
- Turn the switch to OFF if you wish to prohibit alarm input.

Canceling timer programming

To stop timer programming

- Press the [RESET/CANCEL] button.
 - The program being set is canceled.
- Press the [MENU] button twice.
 - The normal screen mode is restored.

To cancel a preset timer program

- Press the [TIMER REC] button to turn off the [TIMER] indication in the display.
- Turn the VCR and the monitor on.
- Press the [MENU] button to display the main menu screen and select <PROGRAM TIMER> with the [SHIFT +/-] button. Then, press the [SET +/-] button.
 - The timer program setting screen is displayed.
- Press the [SHIFT +/-] button to move the cursor arrow to the program No. or the day of the week to be canceled.
- Press the [RESET/CANCEL] button.
 - The specified timer program data is canceled.
- Press the [MENU] button twice.
 - The normal screen is restored.

Changing a preset timer program

- Press the [TIMER REC] button to turn off the [TIMER] indication in the display.
- Turn the VCR and the monitor on.
- Press the [MENU] button to display the main menu screen and select <PROGRAM TIMER> with the [SHIFT +/-] button. Then, press the [SET +/-] button.
 - The timer program setting screen is displayed.
- Press the [SHIFT +/-] button to move the cursor arrow to the program No. or the day of the week to be changed. Press the [SET +/-] button.
 - The timer program setting screen is displayed.
- Select the item to be changed (so that it is blinking) with the [SHIFT +/-] button.
- Change the value with the [SHIFT +/-] button.
- Press the [MENU] button twice.
 - The normal screen is restored.

Using the VCR in the Timer Record Standby mode

Press the [TIMER REC] button to turn off the [TIMER] indication for normal use. Press the [TIMER REC] button again to turn on the [TIMER] indication. The Timer Record Standby mode is engaged. When all timer recording programs have been executed, the [TIMER] indication goes off.

7 RECORDING

7-3 Timer Recording

Notes on timer recording

- If you make a mistake when programming
The [TIMER] indication blinks and the Timer Record Standby mode is engaged.
The blinking of the [TIMER] indication differs depending on the programming status.
 - When correct programs exist, the indication blinks for about 10 seconds and then lights.
 - If mistakes are detected in all programs, the indication blinks for about 10 seconds.

▼

Incorrect programs are canceled automatically. So, if necessary, program the timer again.
 - If no programs have been set
The [TIMER] indication blinks for about 10 seconds. The Timer Record Standby mode cannot be engaged.

▼

Program the timer.
 - If program data overlaps
The Timer Record Standby mode is engaged and the [OVER LAP] indication blinks for about 10 seconds.
The [OVER LAP] indication is not shown, however, if the DAILY timer program and WEEKLY timer program overlap.

▼

Check the program contents.
- When program data overlaps, the timer recording priority is determined as follows.
 - ① The daily timer has priority over the weekly timer.
 - ② The program with shorter recording time (3H>12H>24H) has priority.
 - ③ The program which starts earlier has priority.
 - ④ When the start time is the same, the program with the lower program No. has priority.
- During timer recording
The PAUSE/STILL button has no effect.

▼

To operate the VCR, first press the [TIMER REC] button.
 - Timer recording
Power is turned on about 20 seconds before recording is programmed to start and the VCR enters the Record-Pause mode. Recording starts about 2 seconds before the programmed start time.
 - If no cassette is loaded
The [TIMER] and ([]) indications blink.

▼

Load a cassette with safety tab in place. Cassettes with no tab are ejected.
 - When the <TAPE END MODE> function menu switch is set to STOP, REW or EJECT and the tape ends during timer recording.

▼

The cassette is ejected.
Recording will start again when a cassette with safety tab in place is loaded.

7 RECORDING

7-4 Alarm Recording

Alarm recording functions during timelapse recording. When an alarm signal is input to the rear panel's ALARM IN terminal, an index code is recorded on the tape and the VCR automatically switches to the VHS Standard (SP) mode for realtime recording of the alarm situation. Normal timelapse recording is restored after the preset alarm recording duration has passed.

- * Alarm recording will not start from the Pause mode.

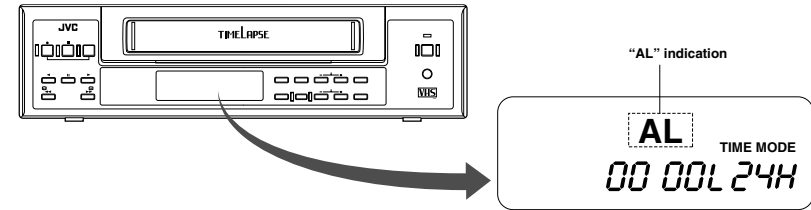

- Set the alarm recording mode, alarm recording duration, buzzer ON/OFF during alarm recording and the operation mode at the tape end during alarm recording with the function menu switches. (Menu switches for alarm/sensor recording mode setting)
- During alarm recording, the AL indication is lit on the display. After alarm recording is complete, the AL indication blinks on the display to show that an alarm signal has been input.

Display "AL" indication	Extinguished	Lit	Blinking	Lit	Blinking
Record mode	Timelapse mode	VHS Standard (SP)	Timelapse mode	VHS Standard (SP)	Timelapse mode
	Timelapse recording	Alarm recording	Timelapse recording	Alarm recording	Timelapse recording
	Alarm signal input		Alarm signal input		

- * An index code (VISS) is recorded at the start point of the alarm recording as an alarm cue signal.
- * During alarm recording, a +12 V signal is output from the rear panel's ALARM REC OUT terminal.

7 RECORDING

7-4 Alarm Recording

Preparation Connect an alarm sensor to the rear panel's alarm input terminal.

- 1 Press the [OPERATE] button to turn the operating mode on.

Setting the function menu switches for the Alarm Record mode

- 2 Press the [MENU] button to display the main menu screen on the monitor.
- 3 Press the [SHIFT +/-] button to select <FUNCTION> and press the [SET +/-] button.

→ The function menu switch setting screen is displayed.

- 4 Press the [SHIFT +/-] button to display the alarm/sensor recording mode setting screen.

- 5 Select the item to be set with the [SHIFT +/-] button. Set the value with the [SET +/-] button.

- Set <ALARM REC> to ON to activate the alarm recording function. The AL REC indication in the display lights.
- Set the alarm recording duration. Set duration to 5 sec., 15 sec., 30 sec., 60 sec., 120 sec., 180 sec., TAPE END or MANUAL (for as long as alarm signals are input).

* When the alarm recording time is set to MANUAL, the alarm cue signal (index code) will not be recorded correctly if alarm input lasts for less than 30 seconds.
* When alarm recording duration is set with an external switcher, set the alarm recording duration to MANUAL.

- To sound the buzzer during alarm recording, set <BUZZER> to ON.
- Set the operation mode at tape end in the case when alarm recording is executed even once with the menu switch <TAPE END MODE> on the alarm/sensor recording mode setting screen.

STOP : The tape stops.

REW : The tape is rewound to the beginning and stops.

REPEAT : Recording continues from the beginning of the tape.

EJECT : The tape is ejected.

- 6 After setting the function menu switches, press the [MENU] button twice.
- The normal screen is restored.

Check the time and data shown on the monitor's on-screen display.

- If the time and date are not shown on the monitor or if

you want to change the display position, use the <POSITION> function menu switch.

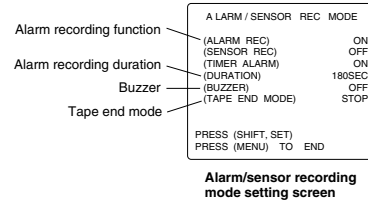

- 7 Select the timelapse recording mode (L12H or L24H) with the [TIME MODE] button on the front panel.
- The selected recording mode is shown on the VCR's display and the on-screen display.

- 8 Follow the procedures for "Basic recording operations" on page 27.

- 9 When an alarm signal is input to the rear panel's ALARM IN terminal, alarm recording is executed as specified.

- 10 To stop alarm recording and clear the alarm indication, press the [AL/PL RESET] button.
 - When the AL indication is lit on the display (during alarm recording), press the [AL/PL RESET] button to stop alarm recording. Timelapse recording is resumed and the AL indication goes out. If the alarm buzzer is on, it stops as well.
 - When the AL indication is blinking on the display, press the [AL/PL RESET] button. The AL indication goes out.

- 11 When the AL indication goes out, press the [AL/PL RESET] button again to reset the alarm input/power loss data.

* There may be some picture distortion at the start or end of an alarm recording. This is not a malfunction.

7 RECORDING

7-5 Sensor Recording

Sensor recording is executed only when the VCR is in the Stop mode (Stop or Timer Record Standby mode) and an alarm signal is input to the rear panel's ALARM IN terminal. Perform the settings for sensor recording in the same way as for "Alarm Recording" on page 33.

The mechanism of the SR-L910E/EK cannot be guaranteed if the sensor recording function is used frequently (100 times/day or more). If alarm inputs are frequent, use the alarm recording function instead and carry out regular maintenance/inspection and parts replacement.

Preparation Connect an alarm sensor to the rear panel's alarm input terminal.

- 1 Press the [OPERATE] button to turn the operating mode on.

Setting the function menu switches for the Sensor Record mode

- 2 Press the [MENU] button to display the main menu screen.

- 3 Press the [SHIFT +/-] button to select <FUNCTION> and press the [SET +/-] button.

→ The function menu switch setting screen is displayed.

- 4 Press the [SHIFT +/-] button to display the alarm/sensor recording mode setting screen.

- 5 Select the item to be set with the [SHIFT +/-] button. Set the value with the [SET +/-] button.

- Set the <SENSOR REC> to ON to activate the sensor recording function. The SENSOR REC indication in the display lights.
- Set the sensor recording duration. Set <DURATION> to 5 sec., 15 sec., 30 sec., 60 sec., 120 sec., 180 sec., TAPE END or MANUAL (for as long as alarm signals are input).

* The sensor recording time will be shorter than the specified value.
* When the sensor recording time is set to MANUAL, the alarm cue signal (index code) will not be recorded correctly if alarm input lasts for less than 30 seconds.
* When sensor recording duration is set with an external switcher, set the sensor recording duration to MANUAL.

- To sound the buzzer during sensor recording, set <BUZZER> to ON.
- Set the operation mode at tape end in the case when sensor recording is executed even once with the menu switch <TAPE END MODE> on the alarm/sensor recording mode setting screen.

STOP : The tape stops.
REW : The tape is rewound to the beginning and stops.

REPEAT : Sensor recording continues from the beginning of the tape.

EJECT : The tape is ejected.

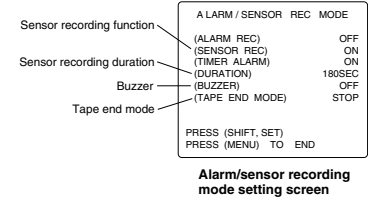

- 6 After completing function menu switch setting, press the [MENU] button twice.
- The normal screen is restored.

Check the time and data shown on the monitor's on-screen display.

- If the time and date are not shown on the monitor or if you need to change the display position, use the <POSITION> function menu switch.

- 7 • When an alarm signal is input to the rear panel's ALARM IN terminal, recording starts automatically in the specified record mode and the AL indication is lit.
 - After the specified recording duration expires, recording stops and the Stop mode is engaged.

* Because sensor recording starts from the Stop mode, it takes several seconds from the time an alarm input is received to the time recording actually starts.

- 8 To stop sensor recording and clear the AL indication, press the [AL/PL RESET] button.

- 9 To disable sensor recording, set menu switch <SENSOR REC> to OFF.

During playback, there may be some noise or picture distortion at the point where one sensor recording stops and another starts. This is not a malfunction.

7 RECORDING

7-6 Repeat Recording

When the tape reaches the end during recording, it is automatically rewound and recording starts again from the beginning.

- To execute repeat recording, set <TAPE END MODE> on the VTR mode 1 setting screen to REPEAT.
- Setting the function menu switch <TAPE END MODE> on the alarm/sensor recording mode setting screen
 - When the tape ends during recording in the case when alarm or sensor recording is executed even once, the tape stops or rewinds and stops at the beginning if this menu switch set to "STOP" or "REW".
 - If this menu switch is set to "EJECT", the tape is ejected.
 - To continue repeat recording even when alarm/sensor recording is executed, set this menu switch to "REPEAT".

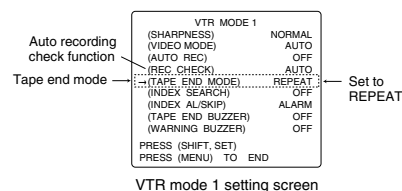

* When repeat recording is performed, the previously-recorded alarm recording is erased.

Auto Recording Check function

This function automatically checks recording quality at the beginning of the tape during repeat recording.

- To activate the Auto Recording Check function, set the <REC CHECK> function menu switch in the VTR mode 1 setting screen to AUTO.

Operation of the Auto Recording Check function

- The recorded section at the beginning of the tape is automatically played back in the Repeat Record mode and the FM level recorded on the tape is checked. If the level is satisfactory, recording continues.
- If recording quality is deemed inferior, the heads are cleaned automatically. After several seconds, recording is checked again.
- If recording quality is still unsatisfactory after two consecutive checks, the error indicator E-09 is shown in the display and recording continues.

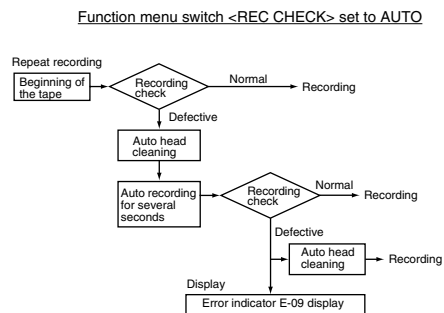

7 RECORDING

7-7 Series Recording

The series recording function facilitates recording over much longer periods using several connected SR-L910E/EKs. As soon as the tape ends in one VCR, the next VCR in the series starts recording.

Connections

- Connect the first VCR's [SERIES/CLOCK OUT] terminal to the second VCR's [SERIES/CLOCK IN] terminal. Connect the second VCR's [SERIES/CLOCK OUT] terminal to the third VCR's [SERIES/CLOCK IN] terminal. Repeat for all connected VCRs. Connect the VCR's [COM] terminals as well.
- Connect a video camera and/or other source equipment to the first VCR's video and audio input connectors. Connect the first VCR's video and audio output connectors to the second VCR's video and audio input connectors. Connect the second VCR's video and audio output connectors to the third VCR's video and audio input connectors. Repeat for all connected VCRs. Connect the last VCR's video and audio output connectors to the monitor's video and audio input connectors.

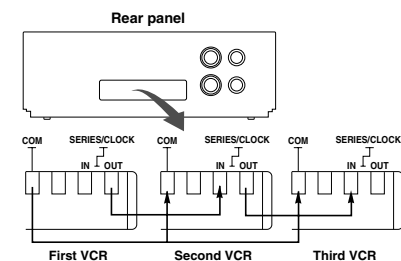

Operations

- Set the <TERMINAL SEL 1> function menu switch on the VTR mode 2 setting screen to "SERIES" (series recording) for all connected VCRs.

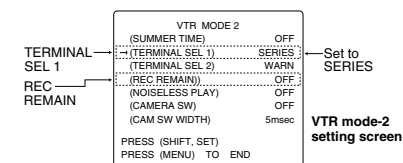

- Output a series recording signal from the [SERIES/CLOCK OUT] terminal to start recording. Select the timing with the <REC REMAIN> function menu switch.
- When set to "OFF", the series recording signal is output when the tape ends.
- When set to "180S", the series recording signal is output about 3 minutes before the tape ends.
- When set to "360S", the series recording signal is output about 6 minutes before the tape ends.

- To end function setting, press the MENU button to close the menu display and restore the time/date display.
- Load cassettes with safety tab in place in all connected VCRs.
- Engage the Record mode on the first VCR. Turn on all connected VCRs and put them in the Standby mode. This allows you to check picture and sound on the monitor. When the recording is complete on the first VCR, the second VCR automatically starts recording. This is repeated for all connected VCRs.

Note

- If a cassette has not been loaded in any VCR in the series, series recording will stop when that VCR is reached.

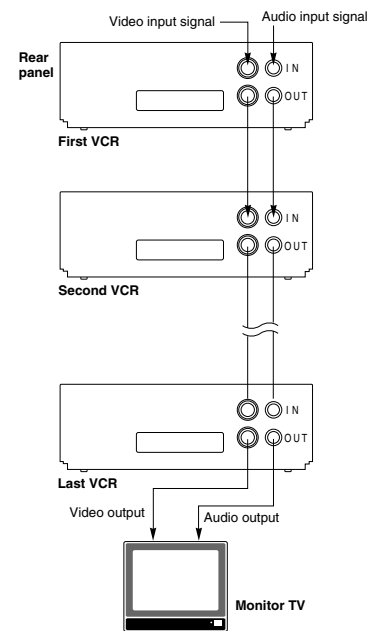

7 RECORDING

7-8 Recording with External VCR Activation Signal

Recording start/stop can be controlled externally by inputting a VCR activation signal to the [SERIES/CLOCK IN] terminal on the SR-L910E/EK's rear panel.

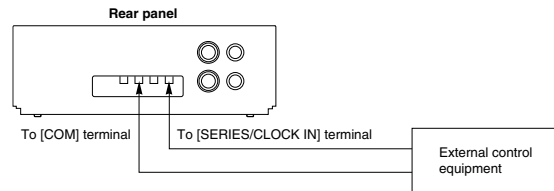

Connection

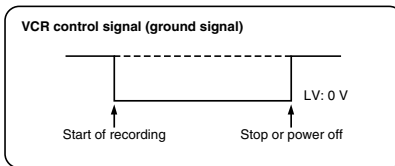

Connect the [SERIES/CLOCK IN] terminal and [COM] terminal on the SR-L910E/EK's rear panel to the external control equipment.

Operation

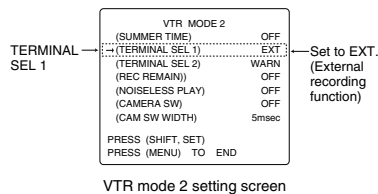

- 1 Set the function menu switch <TERMINAL SEL 1> to "EXT" to use the external recording function.
- 2 Press the MENU button to switch the on-screen display to the time/date display.
- 3 Load a cassette with a safety tab in place and engage the Stop mode, the Pause mode or turn the operating mode off.
 - When a VCR activation signal (ground input) is input to the rear panel's [SERIES/CLOCK IN] terminal, recording starts automatically and continues for as long as the activation signal is input. When the activation signal stops, the Stop or Pause mode is engaged or the operating mode is turned off (depending on the VCR status before the external recording function is used).
 - When the activation signal is input again, recording starts.

- This function has no effect in the Timer Record Standby mode.
- If a VCR activation signal is input while the unit is already recording (started with the [REC] button), recording continues and stops when the activation signal is no longer input.

7 RECORDING

7-9 How to Restore Recording After Power Failure

If a power failure occurs during recording, recording will restart in the same mode as soon as power is restored.

To use this function, set the function menu switch <AUTO REC> to ON.

- * If this function menu switch is set to ON and power is turned off and on again in the Stop mode, the VCR enters the Record mode automatically. Be careful.

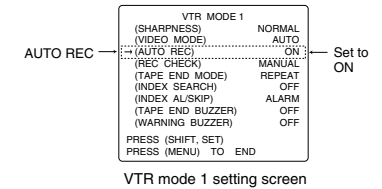

7-10 External Timer Recording

External timer recording can be performed by connecting the SR-L910E/EK to an external timer.

- 1 Check that a cassette is loaded in the VCR.
 - * If the cassette's safety tab has been removed, recording will not take place.
 - * This function does not work when the Timer Record mode is engaged.
- 2 Set the function menu switch <AUTO REC> to ON. Power is supplied from the external timer at the specified time and recording starts.

7-11 Tape End Buzzer

When set to ON, a buzzer sounds when the tape ends during recording. To set the buzzer sound on, set the function menu switch <TAPE END BUZZER> to ON.

- Select the tape end buzzer output timing with the <REC REMAIN> function switch on the VTR mode 2 setting screen.

- OFF : Tape end
- 180S : Remaining time is about 3 minutes
- 360S : Remaining time is about 6 minutes

When the tape reaches the specified position, the following signals are output in addition to the tape end buzzer sound.

- Tape end signal from the rear panel's [TAPE END OUT] terminal
- Series recording signal from the rear panel's [SERIES OUT] terminal during series recording
- "End" indication in the counter display

- To stop the buzzer sound, you can set the <TAPE END BUZZER> function menu switch to OFF, turn off the power, or press another operation button.
- During repeat recording and AUTO REW, the buzzer sounds for about 2 seconds.

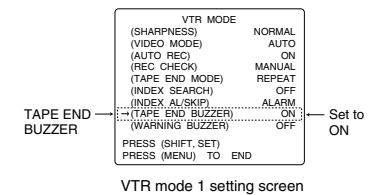

8 PLAYBACK AND SPECIAL-EFFECTS PLAYBACK

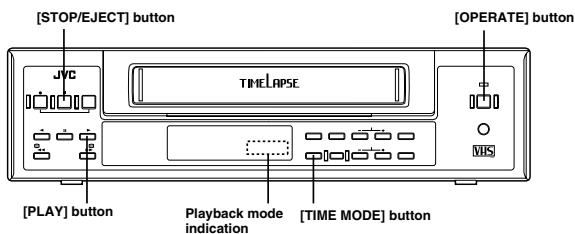

8-1 Preparation

Connection

Make sure the output connectors on the rear panel are properly connected.

Function menu switch settings

Set the function menu switches as required.

- **[SHARPNESS]** . . . **Factory setting: NORMAL**
Set to SHARP to emphasize contours for sharper playback pictures.
- **[INDEX SEARCH]** . . . **Factory setting: OFF**
To enable or disable index search.
 - Set to ON to search the alarm-recorded positions (index code).
- **[NOISELESS PLAY]** ... **Factory setting: OFF**
Set to "ON" to enable frame transport playback when the picture recorded in the 12/24H Timelapse mode contains much noise and is difficult to see. However, there will be no sound output.

Notes

- When a tape recorded in the VHS standard (3H) mode is played back in the Timelapse mode, noise appears in the playback picture.
- Tapes recorded in the Long Play (LP) mode can be played back only. Still, Reverse Play and Shuttle Search modes are not available with LP tapes.

Menu check during playback

- When the [MENU] button is pressed during playback, the monitor screen display switches from the playback picture to the input video signal (EE picture) and the main menu is shown on the screen. This means that even during playback you can check menu contents. Press the [MENU] button again to restore the playback picture.

8-2 Playback

- 1 Press the [OPERATE] button to turn the operating mode on.
→ The [OPERATE] indicator lights.
- 2 Press the [TIME MODE] button to set the Play mode to the VHS Standard (3H).
The 3H indicator is shown on the display.
 - To use playback in the Timelapse Play mode, make sure the same mode (L12H or L24H) is set for playback as was used for timelapse recording.
- 3 Load the recorded cassette correctly.
 - * If a cassette is loaded when the power is off, power is switched on automatically (auto-power on function). If the cassette's safety tab has been removed, power is switched on and play starts automatically (auto play function).
- 4 Press the [PLAY] button to start play.
▶ The play indicator is shown on the display and the Play mode is engaged.
 - Cassettes recorded in the VHS Long Play mode (LP) are played back in the VHS Long Play mode.
 - "6H" is shown in the display.

To stop playback

- 5 Press the [STOP] button.
The tape stops and the Stop mode is engaged.

Audio playback of a timelapse-recorded tape

- Due to the difference in tape speed, audio signals cannot be monitored when a tape recorded in the L12H or L24H Timelapse mode is played back in the VHS Standard (3H) mode. To monitor audio recorded in the Timelapse mode, play back the tape in the same mode (L12H or L24H) as it was recorded in.

8 PLAYBACK AND SPECIAL-EFFECTS PLAYBACK

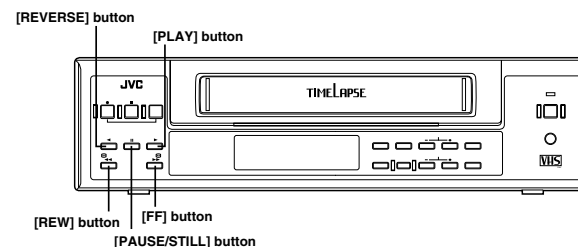

8-3 Special-Effects Playback

Still and field/frame advance

- 1 Press the [PAUSE/STILL] button during playback.
⏸ The still indicator is shown on the display and a still picture is displayed.
- 2 ■ Each time the [PAUSE/STILL] button is pressed in the Still mode, the picture is advanced one field.
 - Pressing and holding the [PAUSE/STILL] button for more than 2 seconds in the Still mode, advances the picture field by field in the forward direction (continuous field advance playback).
 - * No sound is output.
 - In the Field Advance Playback mode, pressing the [PAUSE/STILL] button engages the Still mode.
- 3 Press the [PLAY] button to restore the Normal Play mode.

The Stop mode is automatically engaged if the VCR remains in the Still mode for 5 minutes (approx.).

Reverse playback

- 1 Press the [REVERSE] button in the Play or Still mode.
◀ The reverse indicator is shown on the display and the Reverse mode is engaged.
 - Reverse playback is executed at VHS SP mode speed. When the play time mode is set to 3H, L12H, L24H, 12H or 24H, reverse playback is executed at the VHS SP mode's speed.
 - * No sound is output.
- 2 To return to the Normal Play mode, press the [PLAY] button.

Shuttle search (reverse and fast-forward) playback

Reverse shuttle search
<p>Press the [REW] button during play.</p> <p>◀◀ The rewind search indicator is shown on the display and the Reverse Shuttle Search mode is engaged.</p> <p>* No sound is output.</p>

Fast-forward shuttle search
<p>Press the [FF] button during playback.</p> <p>▶▶ The fast-forward search indicator is shown on the display and the Fast-Forward Shuttle Search mode is engaged.</p> <p>* No sound is output.</p>

Shuttle search operations vary according to how the [REW] or [FF] button is pressed. Refer to the table below for details.

Operation of the [REW] or [FF] button	Tape recorded in the Standard mode or the Timelapse mode
Press the button once.	9 times normal speed (lock). Pressing the [PLAY] button restores the Normal Play mode.
Hold the button pressed for more than 2 seconds.	9 times normal speed. Releasing the finger restores the Normal Play mode.

Note

Still, Reverse Play and Shuttle Search modes are not available with tapes recorded in the Long Play (LP) mode.

8 PLAYBACK AND SPECIAL-EFFECTS PLAYBACK

8-4 Index Search

Searching the index code (VISS signal) recorded at the start of alarm recording helps you quickly locate alarm recordings (index search function).

- To use the index search function, set the function menu switch [INDEX SEARCH] to ON.

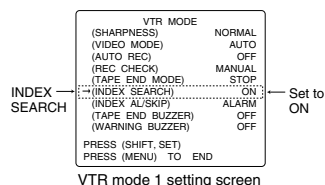

- When reverse shuttle search or fast-forward shuttle search is executed, the Index Search mode is engaged. When an index code is located, playback starts automatically. When the function menu switch [NOISELESS PLAY] is set to OFF, playback takes place in the 3H mode regardless of the set playback mode. When set to ON, playback takes place in the playback mode set with the TIME MODE button.

To engage the Reverse Shuttle Search mode or the Fast-Forward Shuttle Search mode, press the [REW] or [FF] button once during playback.

- When an index code is searched in the Fast-Forward mode or the Rewind mode, the Stop mode is automatically engaged when the code is located.
- The VISS indicator is shown on the display whenever the Index Search mode is engaged.

Index Search does not function in the Auto Rewind mode.

8-5 Tracking/V. Lock Adjustment

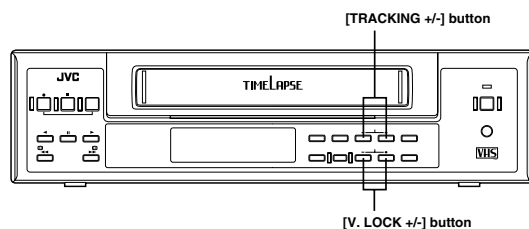

When noise appears in the picture in the Play/Field Advance Play/Search mode

- Tracking can only be adjusted in the following modes:
- VHS Standard (3H) Play, Long Play (LP), 12H and 24H mode
 - Field Advance Playback with the [PAUSE/STILL] button
 - Search mode

- Press the [TRACKING +/-] button to reduce noise. To restore the tracking preset mode, press the + and - buttons simultaneously.

* Tracking adjustment cannot be performed in the L12H/L24H Timelapse Play modes.

When the picture moves up and down in the Still mode

- Press the [V. LOCK +/-] button to minimize vertical jitter.

9 TROUBLESHOOTING

9-1 Error Indication

Error indications are shown on the display whenever there are problems with cassette loading, unloading or mechanism operation.

- When a problem occurs, the error indication E- _ _ blinks.
- When any one of the error indications is shown, a 12 V warning signal is output from the rear panel's WARNING OUT connector (for E-01 to E07, and E-11 during recording) (only when the <TERMINAL SEL 2> menu function switch is set to "WARN").
- When the function menu switch <WARNING BUZZER> is set to ON, the buzzer sounds whenever a problem occurs (for E-01 to E07, and E-11 during recording).

When an error indication appears or the buzzer sounds, turn the operating mode off and then on again to clear the error indication and buzzer sound. When the error indication E- _ _ is shown, turning the operating mode on again may not clear the problem. In this case, consult your local JVC dealer (for E-01 to E-07).

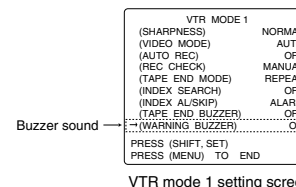
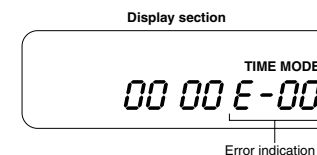

Error indication	Contents	VCR operation	Measures
E-01	Problem with loading operation	The operating mode is turned off.	Turn the operating mode on again.
E-02	Problem with unloading operation	The operating mode is turned off.	Turn the operating mode on again.
E-03	Problem with supply reel rotation	The operating mode is turned off.	Turn the operating mode on again.
E-04	Problem with drum rotation	The operating mode is turned off.	Turn the operating mode on again.
E-05	Problem with take-up reel rotation	The operating mode is turned off.	Turn the operating mode on again.
E-06	Problem with capstan rotation	The operating mode is turned off.	Turn the operating mode on again.
E-07	Problem with eject operation	The operating mode is turned off.	Turn the operating mode on again.
E-09	Error with recording check (inferior recording performance)	Cleans the heads with the VCR's head cleaner.	Cleans the heads with the head cleaning tape, then check the recording picture quality again. The tape may be defective. Replace the tape and check again. If the picture quality is still inferior, consult your local JVC dealer.
E-10	Insufficient capacity of the built-in battery for backup (Displayed only in the operating off mode.)	—	Contact your local JVC dealer to replace the built-in battery.
E-11	No video signals input to the [VIDEO IN] connector	—	Input video signals.

This unit uses a microprocessor and may not function properly if there is external noise or interference. In this case, turn the operating mode off and unplug the power cord from the AC outlet. Then plug the power cord in again and check operation.

9 TROUBLESHOOTING

9-2 No Error Indication

Symptoms	Causes	Remedies
No power is supplied.	<ul style="list-style-type: none"> Is the power cord disconnected? Is the TIMER indication shown? Is the Operation Lock mode engaged? 	<ul style="list-style-type: none"> Connect the power cord to an AC outlet. Press the REC TIMER button so that the TIMER indication goes out. Release the Operation Lock mode.
Operation buttons have no effect during recording and playback.	Is the Operation Lock mode engaged?	Release the Operation Lock mode.
No picture is shown during playback.	Is the monitor connected correctly?	Connect the monitor correctly.
Noise appears in the picture in the Shuttle Search mode and Still mode.	This is not a malfunction.	—
Noise appears in part of the playback picture.	<ul style="list-style-type: none"> Is the tracking adjusted properly? Are you playing back a tape recorded in the VHS SP (3H) mode in the Timelapse mode? In this case, noise appears in the playing picture. 	Adjust the tracking with the [TRACKING+/-] button. Tracking adjustment is not possible in the Timelapse Play mode.
When the cassette is played back, the picture becomes rough or disappears.	Dust may have accumulated on the video heads.	Clean the video heads. Consult your nearest JVC dealer.
During playback, sound is high-pitched and hard to hear.	Are you playing back a tape recorded in the 12H or 24H Timelapse mode in the VHS Standard (3H) mode? In this case, sound is high-pitched.	Play back the tape in the same mode (12H or 24H) as that used for recording.
Recording is impossible.	Has the cassette safety tab been removed?	Paste a piece of cellophane tape over the hole.
Timer recording is working.	<ul style="list-style-type: none"> Is the clock set correctly? Is the timer properly programmed? Is the TIMER indication lit? 	<ul style="list-style-type: none"> Check again. Check it again.
The clock cannot be set.	Is the TIMER indication lit?	Press the TIMER button so that the TIMER indication goes out.
Tape running sound is heard in the Record, Play, FF and REW modes.	This is normal.	If you feel it is too noisy, install the VCR in a rack.
The time/date is not shown.	<ul style="list-style-type: none"> Is the clock set? Is the <POSITION> function menu switch set to OFF? 	<ul style="list-style-type: none"> Set the clock. Set the <POSITION> function menu switch to another position.
During recording, repeat recording does not take place.	Is the function menu switch <TAPE END MODE> in the alarm/sensor recording mode setting screen set to STOP, EJECT or REW? If so, when the tape ends during recording in the case when alarm recording is executed even once, it stops or is rewound to the beginning and stops.	To continue repeat recording even when the alarm recording is executed, set the function menu switch <TAPE END MODE> on the alarm/sensor recording mode setting screen to REPEAT.
Camera image is not switched.	Is the <CAM SW> function menu switch set to "OFF"?	When setting the camera switching timing, set it to "1 FIELD" or "1 FRAME".

10. OPTIONAL SA-K97U RS-232C INTERFACE BOARD

Functions that can be controlled with front panel buttons and switches can also be controlled from a personal computer when the optional SA-K97U RS-232C interface board is installed. Operation status can also be monitored on the computer.

10-1. Installation of the SA-K97U

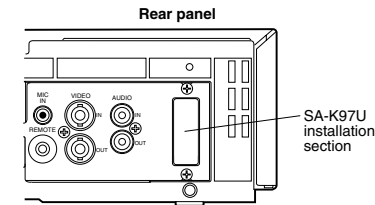

The procedure is shown below. However, to avoid electric shock or injury, contact your local JVC service center for details.

Note:

When installing this board, be careful not to injure yourself on sharp edges and metal parts inside the VCR.

- Before installing the board, turn the power off and unplug the power cord from an AC outlet.

- Detach the top cover. Remove the 5 screws securing the top cover and lift it off.
- Detach the plate in the VCR. Remove the 2 screws on the rear panel. Detach the plate from the inside of the VCR.
- Connect the SA-K97U's connector to the VCR. Insert the SA-K97U connector into the connector (CN607) on the board in the VCR using a tool such as a pincette.

- During insertion, make sure the connector is aligned properly.
- Press both edges of the connector to insert it securely.

- Install the SA-K97U in the VCR. Make sure the SA-K97U bracket is facing the correct direction and align the positioning holes on the bracket with the projections (2 positions) on the VCR's case. Secure the bracket with the 2 screws removed in step 2.

- Attach the top cover as before. Attach the top cover to the VCR using the 5 screws removed in step 1. Make sure you use the correct screws.

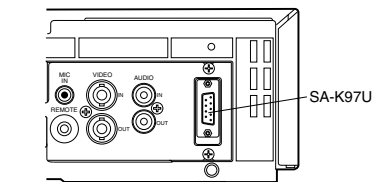
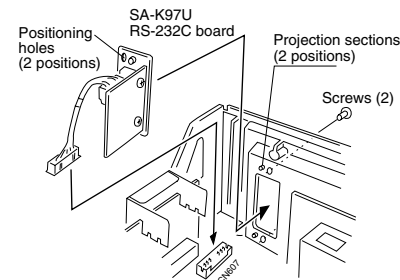
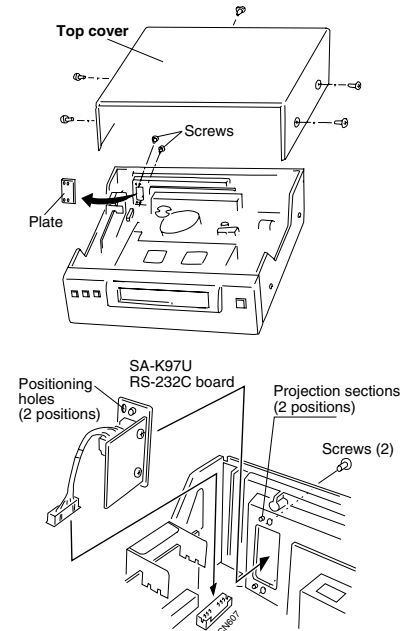

10. OPTIONAL SA-K97U RS-232C INTERFACE BOARD

10-2. SA-K97U Specifications

9-pin connector specifications

Pin NO.	Signals	Operations	Direction of signals
2	RXD	Receive data	VTR ← CPU
3	TXD	Transmit data	VTR → CPU
4	DTR	Data terminal ready	VTR → CPU
5	GND	Signal ground	
6	DSR	Data set ready	VTR ← CPU

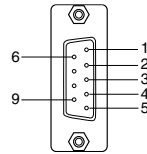

Output level
ON : +5 V or more
OFF: -5 V or less

Data format

- Mode : Non-synchronized
- Character length : 8 bits
- Data rate : 1200, 2400, 4800, 9600 bps
(switched with function menu switch, set to 9600 bps before shipment)
- Parity check : No
- Stop bit : 1 bit

10. OPTIONAL SA-K97U RS-232C INTERFACE BOARD

10-3. SA-K97U RS-232C Protocol & Commands

RS-232C protocol

JVC base table

	0	1	2	3	4	5	6	7	8	9	A	B	C	D	E	F
0				Data "0"	ENTER											
1	COMPLETION			Data "1"	CLEAR ERROR											
2	ERROR			Data "2"											COUNT RESET	
3	CASSETTE OUT			Data "3"							EJECT					
4				Data "4"												
5	NOT TARGET			Data "5"												
6				Data "6"		CLEAR										JVC TABLE1 ON
7				Data "7"										STATUS SENSE		JVC TABLE1 OFF
8				Data "8"												
9				Data "9"												
A	ACK			PLAY	REV PLAY								REC			REC REQUEST
B	NAK										FF		REC PAUSE			VTR INQ
C																
D												REW				
E												F-FIELD STEP				
F				STOP	STILL											

JVC table-1

	0	1	2	3	4	5	6	7	8	9	A	B	C	D	E	F
0				Data "0"	ENTER		TIMER ON	ON SCREEN ON				VISS FWD		FRAME CODE (COUNT)		
1	COMPLETION			Data "1"	CLEAR ERROR		TIMER OFF	ON SCREEN OFF				VISS REV	REC CHECK	DEVICE TYPE	AL_PL RESET	
2	ERROR			Data "2"			PRG/CLK	ROM VER						HOURL METER SENSE	COUNT RESET	
3	CASSETTE OUT			Data "3"			SHFT+				EJECT	SEARCH (VISS)				
4				Data "4"			SHFT-	ON SCREEN SELECT								
5	NOT TARGET			Data "5"			SET+							PL_AL COUNT SENSE		
6	ALARM INPUT			Data "6"		CLEAR	SET-			TL STATUS SET				TL STATUS SENSE		JVC TABLE1 ON
7				Data "7"			CANCEL							STATUS SENSE		JVC TABLE1 OFF
8				Data "8"												
9				Data "9"			OPE LOCK ON									
A	ACK			PLAY	REV PLAY		OPE LOCK OFF						REC			REC REQUEST
B	NAK							OPERATE ON			FF		REC PAUSE			VTR INQ
C								OPERATE OFF			REW					
D								MODE SHIFT			F-FIELD STEP					
E								MODE	DATE SET			DATE S				
F				STOP	STILL				TIME SET			TIME S				

10. OPTIONAL SA-K97U RS-232C INTERFACE BOARD

10-3. SA-K97U RS-232C Protocol & Commands

This section provides technical data for programmers.

Command description

To use the commands described in the following pages, prepare the VCR for communications as follows:

Transmit the command "JVC TABLE 1 ON" (F6H) to the VCR. The VCR will return "ACK" (0AH).
The VCR can now receive any command described in this section. To cancel the communications mode, transmit the command "JVC TABLE 1 OFF" (F7H).

2-1 VCR control commands

Commands (1) through (12) are 1-byte commands. The VCR will return "ACK" (0AH) when the command is received. Confirm that "ACK" (0AH) has been returned before transmitting the next command.

(1) OPERATE ON (7BH)	: VCR operating mode is turned "ON".
OPERATE OFF (7CH)	: VCR operating mode is turned "OFF".
(2) PLAY (3AH)	: Playback
(3) STILL (4FH)	: Pause/Still
(4) STOP (3FH)	: Stop
(5) FF (ABH)	: FF/Forward search in the Play mode. (INDEX Search when Menu switch <INDEX SRCH> is set to ON.)
(6) REW (ACH)	: REW/Reverse search in the Play mode. (INDEX Search when Menu switch <INDEX SRCH> is set to ON.)
(7) REV PLAY (4AH)	: Reverse playback at normal speed
(8) TIMER ON (60H)	: Timer "ON"
TIMER OFF (61H)	: Timer "OFF"
(9) OPE LOCK ON (69H)	: Operation lock "ON"
OPE LOCK OFF (6AH)	: Operation lock "OFF"
(10) EJECT (A3H)	: Cassette ejection VCR returns "ACK", and then returns CASSETT OUT (03H) after cassette has been ejected.
(11) F-FIELD STEP (ADH)	: Engages field advance when the VCR is in the Still mode. The tape is advanced by one field in the 3H/Time-lapse mode. If the VCR is in any other mode, the Still mode is engaged.
(12) REC CHECK (C1H)	: Engages REC CHECK. (function is the same as when locally controlled on the VCR.)

Before transmitting either of the following commands ((13) or (14)), first transmit REC/DUB REQUEST (FAH), and confirm that "ACK" is returned by the VCR.

(13) REC (CAH)	: Starts recording. The VCR returns "ACK".
(14) REC PAUSE (CBH)	: Engages Record-Pause mode. The VCR returns "ACK". • To re-start recording, transmit REC (FAH+CAH). • To cancel Record-Pause, transmit STOP (3FH). The VCR will enter the Stop mode.

However, if the loaded cassette's safety tab has been removed, recording is not possible regardless of the fact that "ACK" has been returned. Use the STATUS SENSE (D7H) command to confirm tape status. (See Section 2-3 (9)).

After transmitting commands VISS FWD (15) or VISS REV (16), transmit the appropriate numeric data (1-byte ASCII codes from 30H to 39H) and the data input command (40H).

ASCII codes "30H - 39H" correspond with the numbers "0 - 9" (ie.: 0: 30H, 1: 31H, ... 9: 39H).

Each byte of numeric data and the data input command should be transmitted separately with "ACK" (0AH) confirmation from the VCR after each transmission. The VCR's Menu switch <INDEX SRCH> is set to OFF.

(15) VISS FWD (B0H)	: To advance the tape in the forward search mode to the designated alarm-input point. The alarm point's 2-byte numeric data should be input after transmission of this command.
(16) VISS REV (B1H)	: To reverse the tape in the reverse search mode to the designated alarm-input point. The alarm point's 2-byte numeric data should be input after transmission of this command.

Eg: To search for the 3rd alarm-input point from the current position.

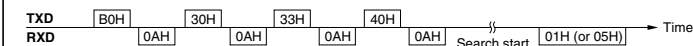

The VCR starts INDEX search after returning "ACK". When the specified point is reached, the VCR returns COMPLETION (01H). If the end or beginning of the tape is reached before the specified point, the VCR returns NOT TARGET (05H). (Sending either the 30H,30H or 30H,31H command will cause the VCR to search for the 1st alarm-input point).

10. OPTIONAL SA-K97U RS-232C INTERFACE BOARD

After transmitting the VISS SEARCH command (17), transmit the appropriate 2-byte numeric data (from 30H to 39H), the data input command (40H), and either FF (ABH) or REW (ACH). All commands should be transmitted separately one byte at a time with "ACK" (0AH) confirmation from the VCR after each transmission.

(17) VISS SEARCH (B3H) : To search for a designated INDEX point on the tape.

The VCR starts INDEX search after returning "ACK". When the specified point is reached, the VCR returns COMPLETION (01H). If the end or beginning of the tape is reached before the specified point, the VCR returns NOT TARGET (05H).
This command differs from commands (15) and (16) only in that the FF (ABH) or REW (ACH) command is included separately.

2-2 VCR setting commands

Commands available include control of recording/playback mode setting, timelapse VCR operation mode setting, date and time setting, timer programming, on-screen setting, and others.

■ Recording/playback mode setting commands

Two commands are available. One allows you to rotate through recording/playback modes, the other permits you to directly select the mode.

- (1) MODE SHIFT (7DH) : Switches from one recording/playback mode to the next each time the command is transmitted. Use the TL STATUS SENSE (D6H) command to check the current mode. (See section 2-3 (8).) Transmit 1 byte at a time with "ACK" (0AH) confirmation from the VCR after each transmission.
- (2) MODE (7EH) : Sets recording/playback mode directly.
After transmitting this command, transmit the appropriate 2-byte ASCII codes (from 30H to 39H) and the data input command (40H). Correspondence of ASCII codes with recording/playback modes is as shown below.

Modes in parentheses are available only in the Play mode.

Eg: To set to "L24H".

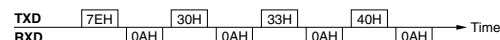

Mode	1st byte	2nd byte
SP	30H	30H
(LP)	30H	31H
L12H	30H	32H
L24H	30H	33H

■ Timelapse VCR operation mode setting commands

- (1) TL STATUS SET (86H) : Set the timelapse VCR operation mode with 3-byte data. Send one byte at a time by checking ACK (0AH) from the VCR.

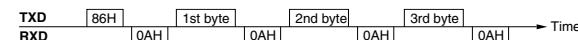

• The setting details for the first to the third bytes are shown below.

1st byte		2nd byte	
BIT	When the bit is "1"	BIT	When the bit is "1"
0	Repeat recording function ON	0	Unused
1	Unused	1	Alarm recording function ON
2	Auto REC mode ON	2	Unused
3	Auto rewind ON	3	Sensor recording function ON
4	Unused	4	External recording function ON
5	Series recording function ON	5	Unused
6	Tape end buzzer ON during recording	6	Index search function ON
7	Alarm recording buzzer ON	7	Warning buzzer ON

3rd byte	
BIT	When the bit is "1"
0	Unused
1	Summer time compensation ON
2	Unused
3	Unused
4	Unused
5	Video mode set to "B/W" (black and white)
6	Unused
7	Unused

10. OPTIONAL SA-K97U RS-232C INTERFACE BOARD

■ Date and time setting commands

- (1) DATE SET (8EH) : Set the current date (month, day, year) for the VCR. After this command (8EH) is sent, input 1-byte numerical data (30H — 39H).

(Example) June, 30, 1998

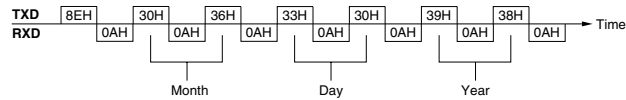

- (2) TIME SET (8FH) : Set the current time (hour, minute, second) for the VCR. After this command (8FH) is sent, input 1-byte numerical data (30H — 39H).

(Example) 15 hours, 29 minutes, 59 seconds

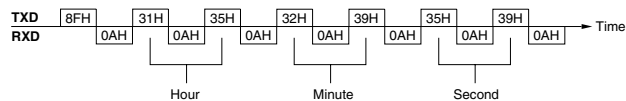

■ Timer programming commands

- (1) PRG/CLK (62H) : Engages timer programming mode.
 (2) SHIFT → (-) (64H) : Selects setting items. (-)
 SHIFT ← (+) (63H) : Selects setting items. (+)
 (3) SET - (66H) : Sets data selected with SHIFT.
 SET + (65H) : Sets data selected with SHIFT.
 (4) CANCEL (67H) : Cancels program data in timer programming or engages the Cancel Program mode.

Setting procedure is the same as when using the VCR controls. Be sure to transmit commands 1 byte at a time with "ACK" (0AH) confirmation from the VCR after each transmission.

■ On-screen setting command

- (1) ON SCREEN ON (70H) : Activates time/date on-screen indication.
 ON SCREEN OFF (71H) : Deactivates on-screen indication.

Setting procedure for the following command (2) is the same as when using the VCR controls. Be sure to transmit commands 1 byte at a time with "ACK" (0AH) confirmation from the VCR after each transmission.

- (2) ON SCREEN SELECT (74H) : Changes the time display position on screen.

■ Other commands

- (1) AL/PL RESET (E1H) : When transmitted during alarm recording, the recording mode switches back to the previous mode. The VCR's "AL" indication goes off. Transmit again after "AL" indicator goes off to reset the alarm/power loss memory.
 (2) COUNT RESET (E2H) : Resets the tape counter to "0000".

10. OPTIONAL SA-K97U RS-232C INTERFACE BOARD

2-3 Commands for VCR status verification

- (1) DATE SENSE (BEH) : The VCR returns the currently set month, day and year as 6 bytes. Each byte has a value of 30H to 39H. 30H corresponds to 0 and 39H to 9.
 (Example: For June, 14, 1998, the VCR returns 30H, 36H, 31H, 34H, 39H and 38H.)
 (2) TIME SENSE (BFH) : The VCR returns the currently set hour, minute and second as 6 bytes. Each byte has a value of 30H to 39H. 30H corresponds to 0 and 39H to 9.
 (Example: For 15:30:45, the VCR returns 31H, 35H, 33H, 30H, 34H and 35H.)
 (3) COUNT CODE (D0H) : VCR returns the counter data beginning with the 4th digit from the right in 4 bytes. ASCII codes "30H — 39H" correspond with the numbers "0 — 9" (eg: 1234: 31H, 32H, 33H, 34H).
 (4) DEVICE TYPE (D1H) : VCR returns the last 4 characters of the SR-L910 model name in ASCII code.
 L: 4CH, 9: 39H, 1: 31H, 0: 30H
 (5) VTR INQ (FBH) : Used to make sure that the connected unit is the VCR. The VCR will return "ACK" (0AH).
 (6) PL/AL COUNT SENSE (D5H) : VCR will return a total of 6 bytes. The first 3 bytes show the number of alarm inputs in 3 digits and the last 3 bytes show the number of power losses in 3 digits. ASCII codes "30H — 39H" correspond with the numbers "0 — 9" (eg: 123 alarm inputs and 45 power losses: 31H, 32H, 33H, 30H, 34H, 35H).
 (7) HOUR METER SENSE (D2H) : VCR returns the hour meter data in 5 bytes. (eg: 12345 hours: 31H, 32H, 33H, 34H, 35H).
 (8) TL STATUS SENSE (D6H) : VCR returns Timelapse mode data in 6 bytes. The contents of each byte are as follows:

1st/2nd byte		5th byte	
Recording/playback mode		Settings status	
Correspondence of the code and the mode is the same as that described in "2-2 Recording/playback mode setting commands (2) MODE (7EH)".			
3rd byte		6th byte	
Conditions of each setting		Types of warnings	
BIT	Status when BIT is "1".	HEX.Data	Types of warnings
0	Not defined. Always 0.	0	No abnormality
1	Power is ON.	1	Loading error
2	Auto REC mode is ON.	2	Unloading error
3	Auto rewind mode is ON.	3	Supply reel error
4	Operation lock is ON.*	4	Drum error
5	Series recording is ON.	5	Take-up reel error
6	Tape end buzzer is ON.	6	Capstan error
7	Alarm buzzer is ON.	7	Cassette eject error
		8	Not defined.
		9	Recording check error
		A	Battery backup error
		B	Input signal error

* Operation with commands from the RS-232C is accepted even in the Operation Lock mode.

10. OPTIONAL SA-K97U RS-232C INTERFACE BOARD

- (9) STATUS SENSE (D7H) : The VCR will return current status information in 5 bytes.

1st byte	
BIT	Status when BIT is "1".
0 Error	Indicates that an illegal command has been received. No further commands will be accepted. To restore to normal operation, transmit CLEAR ERROR (41H) to the VCR.
1 Not defined	Always 0.
2 Not defined	Always 0.
3 Cassette out	The tape has not been loaded.
4 REC inhibit	A tape with no safety tab has been loaded. In this case, no recording commands will be accepted.
5 Not defined	Always 0.
6 Not defined	Always 0.
7 Not defined	Always 1.
2nd byte	
BIT	Status when BIT is "1".
0 Tape End	Tape end sensor is detected.
1 Tape Begin	Tape begin sensor is detected.
2 Not defined	Always 0.
3 Warning	VCR malfunction.*
4 Not defined	Always 0.
5 Not defined	Always 0.
6 A EE Mode	An externally-input audio signal is being output.
7 V EE Mode	An externally-input video signal is being output.
3rd byte	
BIT	Status when BIT is "1".
0 Not defined	Always 0.
1 Search Mode	Search is in progress. (VISS)
2 Repeat Mode	Repeat recording/playback is in progress.
3 Not defined	Always 0.
4 Repeat	VCR's REPEAT REC switch is set to ON.
5 Not defined	Always 0.
6 Timer REC ON	VCR's TIMER button is set to ON.
7 Not defined	Always 0.
4th byte	
BIT	Status when BIT is "1".
0 Not defined	Always 0.
1 REC Mode	VCR is in the Record mode.
2 Eject	A cassette is being ejected.
3 Not defined	Always 1.
4 Stop Mode	VCR is in the Stop mode.
5 REW Mode	VCR is in the Rewind mode.
6 FF Mode	VCR is in the Fast-Forward mode.
7 Play Mode	VCR is in the Play mode.
5th byte	
BIT	Status when BIT is "1".
0 Speed Code 0	VCR's current tape running mode. See below.
1 Speed Code 1	VCR's current tape running mode. See below.
2 Speed Code 2	VCR's current tape running mode. See below.
3 Speed Code 3	VCR's current tape running mode. See below.
4 Shuttle REV	Reverse search is in progress.
5 Shuttle FWD	Forward search is in progress.
6 Not defined	Always 0.
7 Pause Mode	VCR is in the Pause mode.
Contents of 5th byte BIT 0/1/2/3 "Speed Code"	
Speed Code	3 2 1 0
BIT	0 0 0 0 Still
	0 0 0 1 Timelapse playback
	0 1 0 1 Timelapse recording/1X playback
	1 0 0 0 9X search

* When an error occurs in the VCR and the Warning mode is engaged, the third bit of the second byte sent back with the STATUS SENSE (D7H) is set to "1", showing the warning status. In this case, release the warning via the RS-232C with the CLEAR (56H). To release it on the VCR, turn the [OPERATE] button off and on again.

- (10) ALARM INPUT (06H) : SR-L910E/EK return code
This is returned when an alarm signal is input during recording.

10. OPTIONAL SA-K97U RS-232C INTERFACE BOARD

2-4 Others (Input data correction/Error cancellation)

These are return codes from the SR-L910E/EK. (Error-related codes only)

- (1) ERROR (02H) : This is returned when commands of more than 1 byte are transmitted to the VCR and an illegal command is received in the 2nd byte (or later) of the transmitted command. In this status, no command can be accepted and only STATUS SENSE will be returned. To restore normal operation, transmit CLEAR ERROR (41H) or CLEAR (56H) to the VCR.

CLEAR ERROR (41H) : Used to cancel previously-transmitted 1-byte numeric data when inputting numeric data such as an Index search point. Also used to cancel error status.

CLEAR (56H) : Clears the whole command. Cancels the current status and stops the VCR. Also cancels the error status.

Eg : After setting the recording/playback mode to "L24H", 32H is mistakenly transmitted. Cancel 32H with "41H" and input "33H" instead.

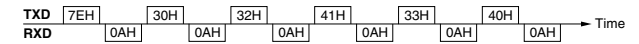

- (2) NAK (0BH) : VCR will return this code when non-defined or non-functional command is received in the 1st byte of the transmitted command. In this case, it is not necessary to input CLEAR. Check whether the transmitted command is acceptable to the VCR or not.

3 Commands reference chart

VCR control commands		Page
OPERATE ON/OFF		48
PLAY/REV PLAY		48
STOP		48
FF/REW		48
TIMER ON/OFF		48
OPE ON/OFF		48
EJECT		48
F-FIELD STEP		48
REC CHECK		48
REC/REC PAUSE		48
VISS FWD/REV		48
VISS SEARCH		49

VCR setting commands		Page
■ Recording/playback mode		49
MODE SHIFT		49
MODE		49
■ Timelapse VCR operation mode		49
TL STATUS		49
■ Date and time setting		50
DATE SET		50
TIME SET		50
■ Timer programming		50
PRG		50
SHIFT -/+		50
SET -/+		50
CANCEL		50
■ On-screen setting		50
ON SCREEN ON/OFF		50
ON SCREEN SELECT		50
■ Others		50
AL/PL RESET		50
COUNT RESET		50

Commands for VCR status verification		
	Page	Byte returned from VCR
COUNT CODE	51	4 bytes
DEVICE TYPE	51	4 bytes
VTR INQ	51	1 byte
PJAL COUNT SENSE	51	6 bytes
HOUR METER SENSE	51	5 bytes
TL STATUS SENSE	51	6 bytes
STATUS SENSE	52	5 bytes
DATA SENSE	51	6 bytes
TIME SENSE	51	6 bytes

Return codes from VCR	
	Page
ACK	48
NAK	53
ERROR	53
CASSETTE OUT	48
COMPLETION	48
NOT TARGET	48
ALARM INPUT	52

Others	
	Page
JVC TABLE 1 ON/OFF	48

11 APPENDICES

11-1 Rear Panel's Input/Output

[CAM SW OUT] camera switching signal output

The CAM SW OUT terminal outputs a camera switching timing signal to the connected sequential switcher. The switching interval can be set with the <CAM SW> on the VTR mode 1 setting screen. The camera switching signal is output at ground level.

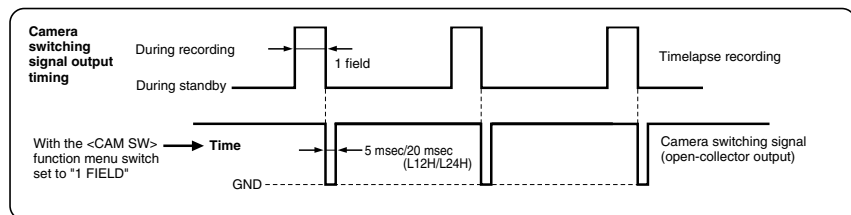

Other input/output terminal signal levels

Terminals	Signal levels	Remarks
ALARM IN Alarm signal input		Input at ground level
ALARM RST IN Alarm signal reset input		Input at high level
ALARM REC OUT Alarm recording mode signal output		Output at high level
TAPE END OUT Tape end signal output		Output at ground level
WARNING/REC OUT Warning signal/Rec mode signal output		Output at high level
CLOCK RESET IN Clock reset input		Input at ground level
CLOCK RESET OUT Clock reset output		Output at ground level

11 APPENDICES

11-2 Specifications

- **Recording system** Luminance: FM recording
Colour: down-converted direct recording
 - **Signal system** PAL-type colour signal, CCIR monochrome signal, 625 lines/50 fields
 - **Tape speed** 23.39 mm/sec., VHS Standard mode (SP)
 - **Recording and playback time** 3 hours (VHS Standard (SP) mode) 12, 24 hours (Timelapse mode: field recording) (with E-180 cassette)
 - **Fast-forward/rewind time** Approx. 4 minutes (with E-180 cassette)
 - **Power supply** AC 220 - 240 V, 50/60 Hz
 - **Power consumption** 19 watts
 - **Dimensions** 360 (W) x 94 (H) x 294 (D) mm
 - **Weight** Approx. 4.5 kg
 - **Operating temperature** 5°C - 40°C
 - **Operating humidity** 30%RH or more, 80%RH or less
 - **Storage temperature** -20°C - 60°C
- [Video System]**
- **Signal input** 0.5 - 2.0 Vp-p, 75 ohms, unbalanced BNC
 - **Signal output** Signal output 1.0 Vp-p, 75 ohms, unbalanced BNC
 - **Horizontal resolution** Colour mode: 240 lines or more (SP mode)
B & W mode: 280 lines or more (SP mode)
 - **Video S/N** 43 dB or more (SP mode)
- [Audio system]**
- **Number of tracks** 1 (normal)
 - **Line input** -8 dBs, 50 kohms, unbalanced RCA
 - **Mic input** -67 dBs, 600 ohms, unbalanced
 - **Line output** -8 dBs, 1 kohm, unbalanced RCA
 - **Frequency response** 100 Hz - 10 kHz (SP mode)
 - **Audio S/N** 40 dB or more (SP mode at 4% distortion level)
 - **Wow and flutter** 0.20% WRMS or less (SP mode)

[Time/date]

- **Display** Day, month, year, hours, minutes, seconds, recording mode
- **Display position** Variable (four corners)
- **Character size** 16H
- **Power backup** Approx. five years (may be less depending on the operating environment)

[Alarm]

- **Alarm input** Input at ground level
- **Camera switching output** Negative pulse output (5 msec.)
Open-collector output

Outer dimensions

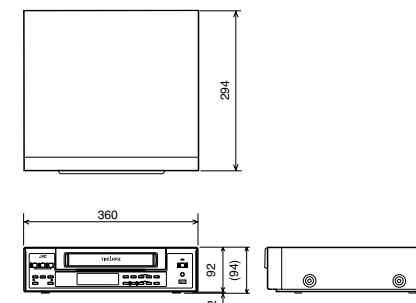

Unit: mm

* Design and specifications subject to change without notice.